

# **LEARNING RESOURCE MATERIAL**

**ON**

**PUBLIC HEALTH ENGINEERING**

**UNDER EDUSAT PROGRAMME**



**SCTE&VT, BHUBANESWAR  
ODISHA**

**Coordinator :- Sri E. Ekka , Sr. Lecturer(Civil)  
U.C.P. Engineering School,  
Berhampur**

**Nodal Officer :- Dr. S.K. Nayak, Trg. Supdt.  
G.P., Bhubaneswar**

## CONTENT

Chapter No.	Topic Name	Page No.	Prepared by
	<b>A: WATER SUPPLY ENGG.</b>		
01.	Introduction	<b>3 - 4</b>	Lalima Priyadarsini Behura, Lect.(Civil), ITT, Choudwar
02.	Quantity of Water	<b>5 - 11</b>	-Do-
03.	Sources of Water	<b>12 - 19</b>	-Do-
04.	Conveyance of Water	<b>20 - 29</b>	-Do-
05.	Quality of Water	<b>30 - 40</b>	Smt. Asha Mishra, Sr. Lect.(Civil), BOSE, CTC
06.	Treatment of Water	<b>41 - 58</b>	-Do-
07.	Distribution system	<b>59 - 64</b>	-Do-
08.	Appurtenance in Distribution System	<b>65 - 67</b>	Sri D.K. Mohapatra Lect.(Civil), ITT, Choudwar
09.	W/S plumbing in building	<b>68 -73</b>	-Do-
	<b>B: SANITARY ENGINEERING</b>		-Do-
10.	Introduction	<b>74 - 76</b>	-Do-
11.	Quantity of sewage	<b>77 - 98</b>	Smt Malabika Patra Lect.(Civil), SKDAV GP, RKL
12.	Sewerage system	<b>99 - 118</b>	-Do-
13.	Sewer appurtenances	<b>119 - 143</b>	-Do-
14.	Sewage Characteristics	<b>144 - 152</b>	Sri Sibasis Panda Lect.(Civil), GP, Kandhamal
15.	Sewage disposal	<b>153 - 157</b>	-Do-
16.	Sewage treatment	<b>158 - 177</b>	-Do-
17.	Sanitary Plumbing for Building	<b>178 - 191</b>	Sri M.R. Nayak Sr. Lect.(Civil), UCPEs, BAM
18.	Rural Water Supply & Sanitation	<b>192 - 200</b>	-Do-

# **WATER SUPPLY ENGINEERING**

## **CHAPTER-1**

### **INTRODUCTION**

The branch of civil engineering which deals with the supply of water for various purposes e.g. domestic, industrial, commercial & public is called **Water Supply Engineering**.

#### **Necessity:-**

Water is the most essential commodity for the continuation of life. An adequate & clean water supply is the basic requirement for domestic use for various purposes like—

- (i) for drinking & cooking
- (ii) for bathing & washing
- (iii) for watering of lawns & gardens
- (iv) for air-conditioning system
- (v) for street washing etc.

Water is also required for various types of industrial & commercial purposes.

#### **Historical Development:-**

During British Rule in India, the works of sanitation were given to the local bodies of the towns. The local bodies took these works, but due to lack of technical staff with them, they could not do satisfactory progress. In 1948 Union Government appointed the Environmental Hygiene Committee, which put up their recommendations on the broader field of environmental hygiene. The committee also recommended a comprehensive plan for providing water supply & sanitation facilities to 90% population within 40 years. But no special measures were taken to implement these recommendations.

In first Five year plan (1951-1956) provision of water supply & sanitation scheme in the states were made in the community Development Works & Local development works. In 1953, the Union Health Ministry noted from the enquiry that the state government could not do satisfactory progress in this matter from their own resources. With the result, the Union Health Ministry announced in 1954 their National Water Supply & Sanitation programme as a part of the Health schemes, & also made specific provisions to assist the states in this matter. Under this scheme approved urban schemes got loans , while rural schemes up to 5000 population , got 50% grant-in-aid by central government & part of

remaining 50% was grant-in-aid by State Government & part as contributions from the villagers either in cash or in labour or in material.

During 1960 Ministry of Health formed National water supply & sanitation committee for reviewing the progress of work of National water supply & sanitation programme & for correct assessment of urban & rural requirements. The report of this committee shows that 60% towns of India cover only 6.5% of total population. Out of this only 48.5% population was supplied with safe water that too 10 to 150 litres capita/day.

In fourth five year plan Rs.339 crores was arranged for water supply and sewerage. A number of water supply & sewerage schemes were completed .For removing water borne diseases number of schemes were completed. Provision of Rs. 100 crores was done for schemes supplying water to the rural areas of acute scarcity. In India, there was always shortage of funds for its various projects . But in spite of all efforts the expenditure in water supply & sanitation remains within 3% of total plan outlay, which may be considered as good amount. After spending such amounts , in India, its 85% urban population gets safe drinking water. But in rural areas , major work still remains to arrange safe water to its population.

## CHAPTER –2

### QUANTITY OF WATER

#### Introduction:-

During planning a water supply scheme , it is the duty of the engineer to carefully examine the various types of water demand of the town & then to find out the suitable water sources from where the demand can be met.

The various types of water demand of a city or town are:-

- (i) Domestic Water Demand
- (ii) Commercial & Industrial Demand
- (iii) Demand for public uses
- (iv) Fire Demand

**Domestic Water Demand:-**This demand includes the quantity of water required in the houses for drinking, cooking, bathing, washing, gardening, sanitary purposes etc. It mainly depends upon the living conditions of the consumer. As per IS:1172-1963 water required for domestic purposes for average Indian condition per head per day may be taken as 135 litres. In developed countries this may be as high as 350 litres. The total domestic water consumption may amount to 50 to 60% of the total water consumption.

#### Detail of water requirement for Domestic purposes:-

Sl.No.	Description	Consumption of water per head per day in litres
1.	Drinking	5
2.	Cooking	5
3.	Bathing	55
4.	Washing of clothes	20
5.	Washing of utensils	10
6.	Washing of houses	10
7.	Flushing of Latrines etc.	30
	Total	135

**Commercial & Industrial Water Demand :-** This includes offices, hotels, hospitals, schools, stores, Shopping centres etc. This demand depends upon the nature of the city, number and types of industries. On an average, 20 to 25% of the total water demand may be allowed for this type of demand in the design.

**Demand for public uses :-** Public demand includes the quantity of water required for public utility purposes such as watering of public parks, gardening, sprinkling on roads, use in public fountains etc. In many water supply schemes these demands are not believed as essential and a nominal amount not exceeding 5% of the total demand is kept on arbitrary basis.

**Fire Demand :-** It is the quantity of water required for fighting a fire outbreak. For high value cities , water requirement for this purpose is particularly essential. The quantity of water required for this purpose can be found out by applying certain empirical formula. These are :-

- (i) National Board of Fire Underwriters Formula :

$$Q = 4640P^{1/2} (1 - 0.01P^{1/2})$$

Where Q = Quantity of water required in litres per minute.

P = Population of the town in thousands

- (ii) Freeman formula :

$$Q = 1135.5((P/10)+10)$$

- (iii) Kuichling's Formula :

$$Q = 3182P^{1/2}$$

**Per capita Demand :-**

It is the annual average amount of daily water required by one person and includes the domestic, industrial , and public use.

If Q = total quantity of water required by a city per year in litres &

P = Population of the city

Then Per Capita Demand in litre per day =  $Q / (P * 365)$

**Variation in Demand:-**

It has been seen that the demand does not remain uniform throughout the year, but it varies from season to season, even from hour to hour. So variation in rate of demand may be termed as :

- (i) Seasonal variation.
- (ii) Daily variation.
- (iii) Hourly variation.

**Seasonal Variation:-** In Summer the water demand is maximum, because people will use more water in bathing , cooling, lawn watering, street sprinkling etc. This demand goes on reducing & in winter it becomes minimum, because less water will be used in bathing & there will be no lawn watering.

**Daily Variation :-** The rate of demand may vary from day to day also. This is due to habits of the consumer, climatic conditions, holidays etc. On hot and dry day water requirements will be more as compared to a rainy day.

**Hourly Variation :-** The rate of demand during 24 hours does not remain uniform & it varies according to hours of the day. On Sundays & other holidays the peak hours may be about 8 A.M due to last awakening whereas it may be 6 A.M. on the other working days. Certain industries may be working in day & night shifts & consuming more water.

### **Factors affecting Per Capita Demand :-**

The various factors which affect the per capita demand are :-

1. **Climatic condition :-** Water requirements during summer are more than winter . During summer more water is used for bathing , drinking & also more water is consumed in running coolers etc. Hence water consumption is much more in summer than that in winter.
2. **Size of city :-** Generally the demand of water per head will be more in big cities than that in small cities. In big cities lot of water is required for maintaining clean & healthy environments while in small towns it is not required.
3. **Habits of people :-** High class community uses more water due to their better standard of living & higher economic status. Middle class people use water at average rate and for poor people ,a single water tap may be sufficient for several families.
4. **Industries :-** More water will be required in highly industrialised city .
5. **Cost of water :-** More costly is the water less will be rate of demand. Hence the cost at which water is supplied to the consumer may also affect the rate of demand.

6. **Quality of water :-** A water works system having a protected & good quality of water supply would always be more popular with consumers. Hence more quantity of water will be consumed if the quality is good.
7. **Pressure in the distribution system :-** These would be of great importance in the case of localities having a number of two or three storied buildings. Adequate pressure would mean an uninterrupted and constant supply of water.
8. **System of supply :-** The system of supply may be continuous or intermittent. In continuous system water is supplied all the 24 hours while in case of intermittent system , water is supplied for certain fixed hours of the day only, result in some reduction in the consumption. This may be due to decrease in losses & other wasteful use.

### Methods of forecasting population:-

The following are the methods used for forecasting population :

- (i) **Arithmetical Increase Method :-** In this method, the increase in population is assumed to be constant and an average increase of the last 4 to 5 decades is calculated and added in the present population to determine population of the next future decade. The population can be found out at the end of “n ” year or “n” decades.

$P_n = P + n \cdot i$  ( where  $P =$  Present population ,  $i =$  Yearly or per decade increase in population ).

- (ii) **Geometrical Increase Method :-** In this method the average %age of growth of last few decades is determined. The population forecasting is done on the basis that %age increase per decade will be the same. Thus population at the end of “n” years or decades is given by :

$$P_n = P ( 1 + (i/100))^n$$

Where  $i =$  % age rate of increase per decade

- (iii) **Incremental Increase Method :-** This method is improvement over the above two methods . The average increase in the population is determined by the arithmetical method and to this is added the average of the net incremental increase once for each future decade . Thus population at the end of “n” years or decades is given by :

$$P_n = P + n (I_a + I_c)$$



Where  $I_a$  = Average Arithmetical Increase &

$I_c$  = Average incremental Increase

- (iv) **Decreasing Rate Method :-** In this method the average decrease in the %age increase is worked out and is then subtracted from the latest %age increase for each successive decade.

**Problem :-**

The following data have been noted from the census department.

Year	Population
1940	8,000
1950	12,000
1960	17,000
1970	22,500

Calculate the probable population in the year 1980, 1990 & 2000.

Answer by using Arithmetical Increase method :

Year	Population	Increase in population
1940	8,000	-----
1950	12,000	4000
1960	17,000	5000
1970	22,500	5500
	Total	14,500
	Average	4,833

**Solution:**

Year	Population
1980	$22,500 + 1 * 4833 = 27,333$
1990	$27333 + 1 * 4833 = 32,166$
2000	$32166 + 1 * 4833 = 36,999$

**Answer by using Geometrical Increase Method :**

Year	Population	Increase in	Percentage increase
------	------------	-------------	---------------------

		population	in population
1940	8,000	-----	-----
1950	12,000	4000	$(4000/8000) * 100 = 50.0\%$
1960	17,000	5000	$(5000/12000) * 100 = 41.7\%$
1970	22,500	5500	$(5500/17000) * 100 = 32.4\%$
Total		14,500	124.1
Average per decade		4,833	41.37

**The population at the end of various decade will be as follows :**

Year	Expected population
1980	$22,500 + (41.37 / 100) * 22,500 = 31,808$
1990	$31,808 + (41.37 / 100) * 31,808 = 44,967$
2000	$44,967 + (41.37 / 100) * 44,967 = 63570$

**Answer by using Incremental Increase Method :**

Year	Population	Increase in Population	Incremental Increase
1940	8,000	-----	-----
1950	12,000	4000	-----
1960	17,000	5000	+1000
1970	22,500	5500	+500
Total		14,500	+1500
Average		4,833	+750

**The population at the end of various decade will be as follows :**

Year	Expected population
1980	$22,500 + 1(4833 + 750) = 28,083$
1990	$28,083 + 1(4833 + 750) = 33,666$
2000	$33,666 + 1(4833 + 750) = 39,249$

**Answer by using Decreasing Rate Method :**

Year	Population	Increase in Population	Percentage increase in population	Decrease in the % age increase
1940	8000	-----	-----	-----
1950	12000	4000	$(4000/8000) * 100 = 50$	-----
1960	17000	5000	$(5000/12000) * 100 = 41.7$	+ 8.3
1970	22500	5500	$(5500/17000) * 100 = 32.4$	+ 9.3
Total		14500		17.6
Average		4833		8.8

**The population at the end of various decade will be as follows :**

Year	net %age increase in population	Expected Population
1980	$32.4 - 8.8 = 23.6$	$22,500 + (23.6/100) * 22,500 = 27,810$
1990	$23.6 - 8.8 = 14.8$	$27,810 + (14.8/100) * 27,810 = 31,926$
2000	$14.8 - 8.8 = 6.0$	$31,926 + (6.0/100) * 31,926 = 33,842$

## CHAPTER – 3

### SOURCES OF WATER

#### Surface sources:-

The sources of water in which the water flows over the earth surface are called surface sources . The surface sources are mainly classified as :- River, Stream & Lakes , Impounding reservoir .

**Rivers, Stream & Lakes :-** They are formed by rainfall runoff i.e. rain water flowing along the ground into these natural drainage depressions .Quantity varies depending on the catchment.

**Rivers:-** Rivers are born in the hills , when the discharge of large number of springs and streams combine together. Rivers are the only surface sources of water which have maximum quantity of water which can be easily taken. **Streams** . In mountainous regions streams are formed by the run off . The discharge in streams is much in rainy season than other seasons. The quality of water in streams is normally good except the water of first run-off.

**Lakes :-** In mountains at some places natural basins are formed with impervious beds. Water from springs & streams generally flows towards these basins and Lakes are formed . The quantity of water in the lakes depends on its basin capacity , catchment area, annual rainfall & porosity of the ground etc.

**Impounded Reservoirs :-** It may be defined as an artificial lake created by the construction of a dam across a valley containing a water course . The object is to store a portion of the stream flow so that it may be used for water supply. The reservoir consists of three parts :

- (i) A dam to hold back water
- (ii) A spillway through which excess stream flow may discharge
- (iii) A gate chamber containing the necessary valves for regulating the flow of water from the reservoir .

#### Underground Sources :-

These are the sources of water which supply water from below the earth surface. They include Springs , wells & galleries.

**Springs :-** Ground water reappears at the ground in the form of springs. Springs are brought about under the following conditions :

- (i) When the surface of earth drops sharply below the normal ground water table , the water bearing stratum is exposed to the atmosphere and the springs are created. The formation of such springs results from an overflow of the ground water table. This type of spring is also called as **Gravity** or **Shallow springs** (Refer Fig. 3.1) and the water table in such springs varies with the rainfall .

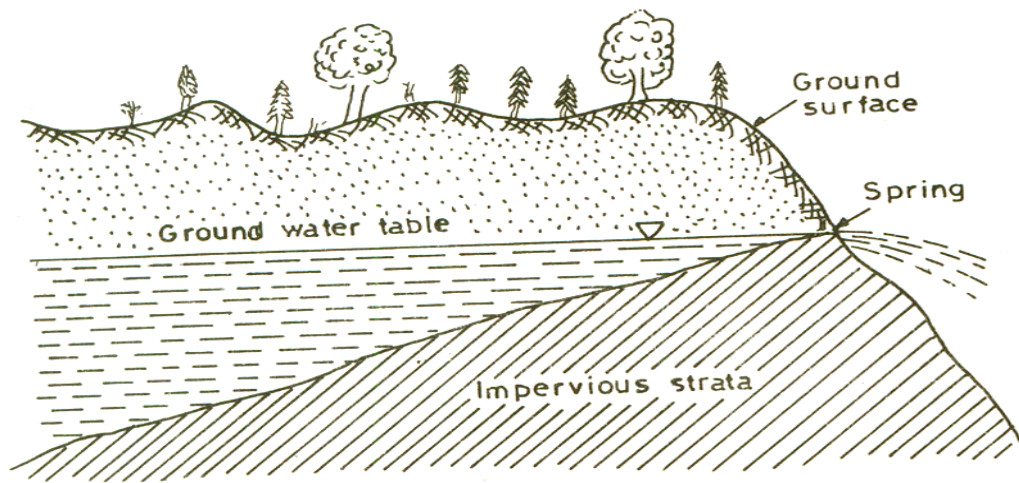

Fig. 3.1(Shallow Spring)

- (ii) When due to an obstruction ground water is stored in the form of a reservoir, & this water is forced to overflow at the surface. Springs of this type are the most common. These are formed when an impervious stratum , which is supporting the ground water reservoir becomes outcrops (Refer Fig. 3.2) .

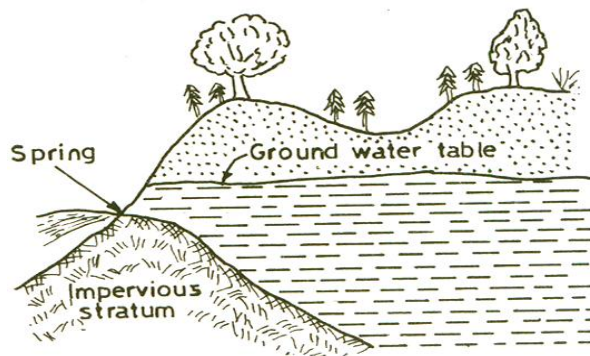

Fig. 3.2 (Spring)

- (iii) When the fissure in an impervious stratum allows artesian water to flow in the form of springs. Such types of springs come across when the ground water rises

through a fissure in the upper impervious stratum . These are also known as **Artesian Springs** (Refer Fig. 3.3). The amount of water available is large & the rate of flow of water is constant because water comes out by a constant pressure.

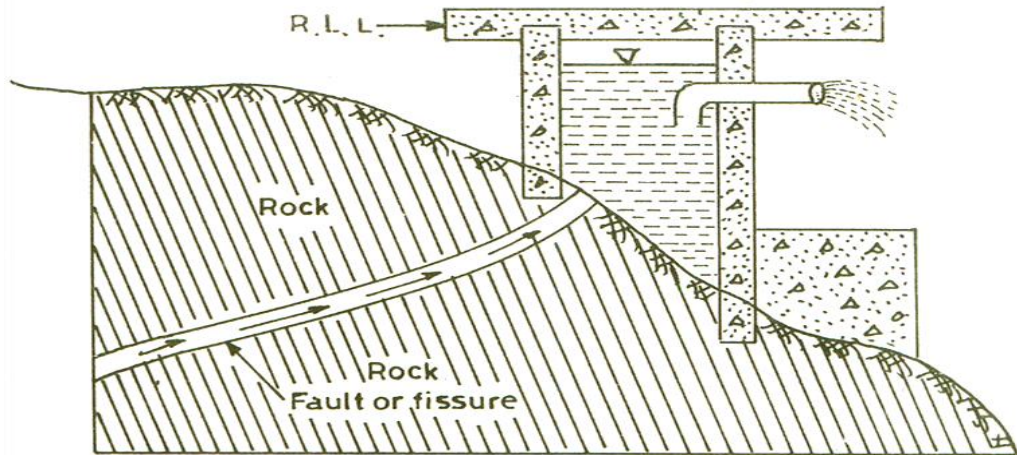
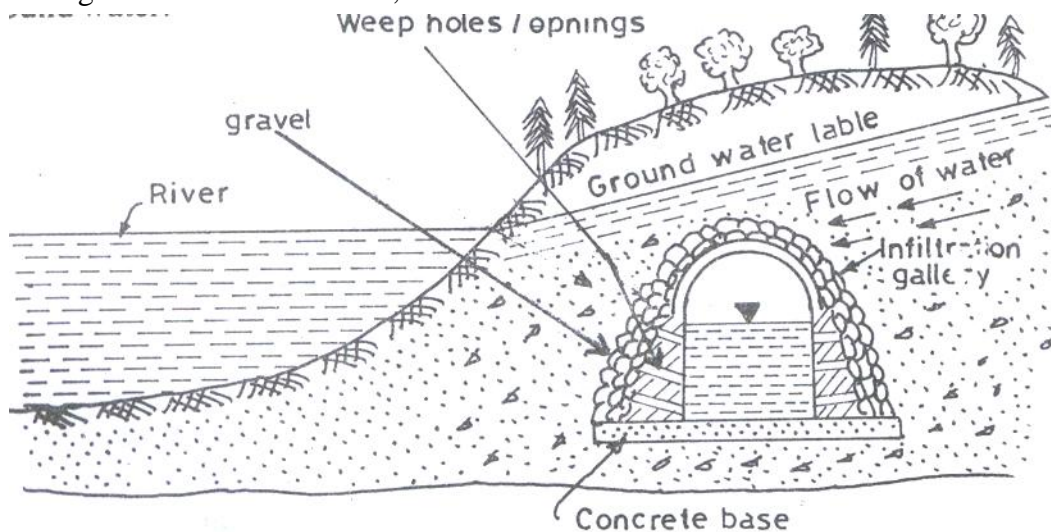

Fig. 3.3(Formation of spring due to a fault in a rock)

**Infiltration Galleries.** (Refer Fig. 3.4) :- A gallery is a horizontal or approximately horizontal tunnel constructed through water bearing material in a direction approximately normal to the direction of flow of the underground water. As we know that sub-surface water always tries to travel towards lakes, rivers or streams. This travelling water can be intercepted by digging a trench or by constructing a tunnel with holes on sides at right angle to the direction of flow of underground water. These underground tunnels used for tapping underground water near lakes , rivers etc are called Infiltration Galleries.



(Fig. 3.4)

**Infiltration Well :-** An infiltration gallery may be a line of wells closely spaced & placed across a normal to the direction of underground flow in an aquifer. These are commonly placed close to the bank of a river or a lake to intercept the underground flow towards the body of surface water. Wells so placed are called Infiltration Wells. It may be more economical to draw potable water from beneath a river by such means than to purify the surface water taken directly from the river.

### Well :-

The vertical hole dug into the ground to get sub- surface water is called a well . Wells are generally classified as : Shallow well & Deep Well (Refer Fig. 3.5)

- ⇒ A shallow well is that well in which the water is obtained from the upper most water bearing stratum without encountering any impervious stratum. The yield of the shallow well is uncertain due to large variation in the ground water level throughout the year.
- ⇒ A deep well is that well in which the water is obtained from the underneath of an impervious layer. The yield of a deep well is greater & constant as there is no quick fluctuation of the water level .

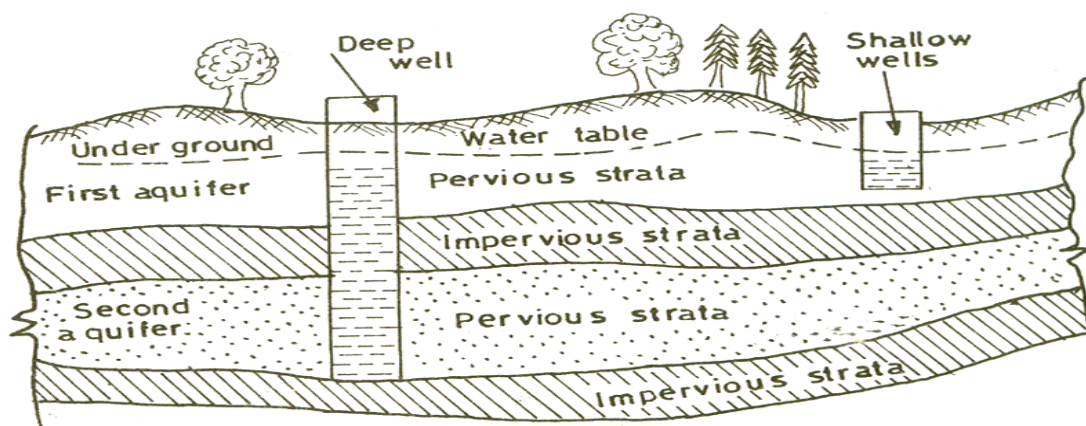

Fig. 3.5 (Shallow & deep well)

### Types of Well:-

- According to condition of flow , wells may be classified as : Gravity wells & Pressure wells.

When the surface of the water in the water bearing stratum surrounding the well is at atmospheric pressure , the well is called **gravity well**.

When the aquifer is confined between two impervious layers, one above & other below, & the water in this aquifer is at a pressure greater than atmospheric , the well is called **pressure well**.

- According to the type of construction , wells may be classified as : Dug Wells , Bored Wells or Tube Wells & Driven Wells.

**Dug Wells :-** Small dug wells are generally excavated by hand. In loose soils, they are lined with brick, rubble or concrete. In rock, they are commonly left unlined. This lining is termed as “**Curb**”. In the case of a well used for domestic purposes , the upper portion of the curb is made impervious for a depth of 1.80m to 2.40m .Dug wells should be completed when the water table is at its lowest level .

**Bored Wells or Tube Wells(Refer Fig. 3.6) :-** This type of well can be bored by using hand or power augers into cohesive soils . Above the water table , the excavated soil is collected in the auger , which is raised time to time to remove the collected soil . When the boring is done below the water table , sand may wash out of the auger and have to be removed from the bore hole by hand auger . The holes varying from 5 to 75 cm in diameter & 9 to 12m depth can be bored by hand auger , whereas power augers will drill holes of diameters ranging from 20 to 75 cm and depth 7.5 to 90m .

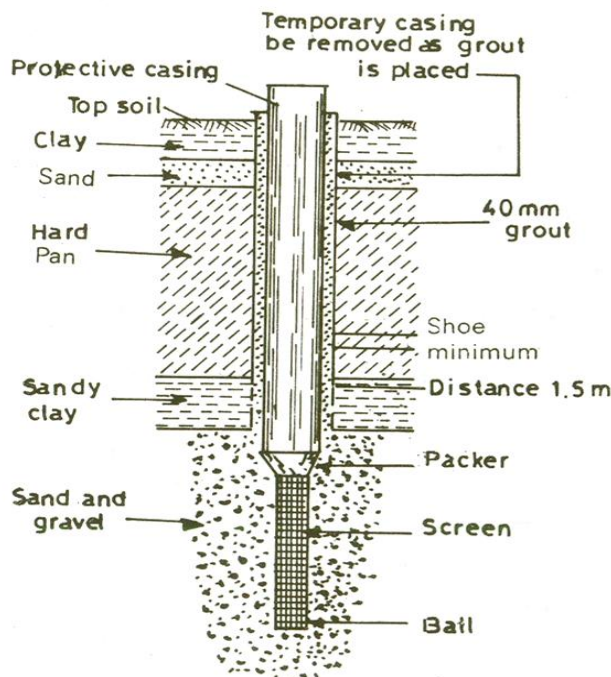

Fig. 3.6 (Bored or Tube well)



**Driven Wells (Percussion Wells) :** For domestic use , percussion type or driven wells develop smaller water supplies. The reason for this is that driven wells are shallow and of smaller diameter. This is because of the difficulty in driving a large pipe to greater depths. All such wells will be located round a collecting well with a suction pump at a distance not exceeding 9m. Driven wells are adopted to soft , granular formation. Percussion well consists of a drive point & a pipe as shown in Fig. 3.7. A piece of pipe pointed at one end & perforated for remaining length is driven into a water-bearing formation by a wooden hammer or hydraulic ram. The diameter of the casing varies from 2.5 cm to 15cm. The whole pipe should be driven perfectly vertical as far as possible.

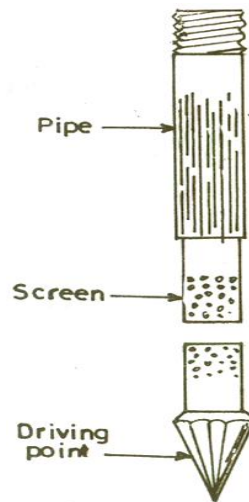

Fig. 3.7 (Percussion Well)

### **Yield from Well :-**

Yield has been defined as the amount of water flowing into the well per unit time. It is expressed in litres per second or sometimes in cubic meter per day.

### **Methods of determination of Yield of the well:-**

If  $D$  = the vertical distance from the water table to the bottom of the well.

$d$  = the depth of water in the well

$R$  = the radius of the circle of influence

$r$  = the radius of the well

$p$  = porosity ratio

$k$  = constant, then

Yield of the well  $Q = K_m (D^2 - d^2) / \log_{10} (R/r)$  litre per minute.

Where Transmissibility constant  $K_m = 3.143pk * 1000 / (24 * 60 * 2.303)$

**Problem :**

The following observations were made on a 30 cm diameter tube well :—

- (i) Rate of pumping = 1500 litre / minute ,
- (ii) Draw down in a test well 30m away =1.5m,
- (iii) Draw down in another test well 60m away = 0.6m,
- (iv) Depth of water in the well before pumping = 40m.

Determine the radius of the circle of influence & the transmission constant.

**Ans. :** Given  $H = 40m$  ,  $h = 40 - 0.6 = 39.4m$

So here  $Q = K_m (D^2 - d^2) / \log_{10} (R/r)$  litre per minute  
 $= K_m (40^2 - 38.5^2) / \log_{10} (R/30) = K_m (40^2 - 39.4^2) / \log_{10} (R/60)$

Solving for R by trial & error ,we get  $R = 94m$ .

Now solving for  $K_m$  ,

$$15.0 = K_m (40^2 - 38.5^2) / \log_{10} (94/30)$$
$$\Rightarrow K_m = 6.31 \text{ (Ans.)}$$

**Measurement of an open yield :-**

The yield can be determined by the following two methods:

- (i) Actual Pumping Method
- (ii) Theoretical Method

**Actual Pumping Method :**

The specific yield of a well can be determined by the following formula –

$$C' / A = (2.303 / T) \log_{10} (S_1 / S_2)$$

Where ,

$C'/A$  = Specific yield.

$S_1$  = Depression head in the well at the time immediately after the pumping was stopped.

$S_2$  = Depression head in the well at time “t ” after the pumping was stopped.

T = Time after pumping when measurement  $S_2$  was taken.

Knowing the value of  $C'/A$  , the discharge “Q” of the well can be determined by –:

$$Q = (C'/A) * A * S$$

Where , A = Cross sectional area of the well

S = Depression head

**Theoretical Method :-**

The approximate quantity of water entering or percolating in the wall can be calculated as :

$$Q = A * V * B$$

Where A = cross sectional area of the well opening

V = Velocity of water percolating in the well & B = Permeability constant.

**Problem :**

The water level in an open well was depressed by pumping up to 3.0 meter. The water level was raised by 1.5meter within 50 minutes just after stopping the pumping . Determine Yield from well , if the diameter of the well is 2.5 meter & the depression head is 3.3 meter.

Ans. Given  $S_1 = 3.0\text{m}$ ,  $S_2 = 3 - 1.5 = 1.5\text{m}$  ,  $T = 50 \text{ minutes} = 3000 \text{ sec}$

$$C' / A = (2.3 / T) \log_{10} (S_1 / S_2)$$

$$\Rightarrow C' / A = (2.3 / 3000) \log_{10} (3 / 1.5)$$

$$\Rightarrow C' / A = 0.0002307$$

If  $d = 2.5\text{m}$  &  $S = 3.3\text{m}$ , then  $A = 3.142d^2 = 4.909 \text{ m}^2$

Then  $Q = (C' / A) * A * S = 0.0002307 * 4.909 * 3.3$

$$= 3.737 * 10^{-3} \text{ litre per second} \quad \text{Ans.}$$

## CHAPTER – 4

### CONVEYANCE OF WATER

#### Intake :-

A device placed in a surface water source to draw water from this source & then discharge into a conduit through which it will flow into the water work system , is called intake. It consists of a conduit with protective work, screen at both ends , gates and valves to regulate the flow as shown in fig. 4.1.

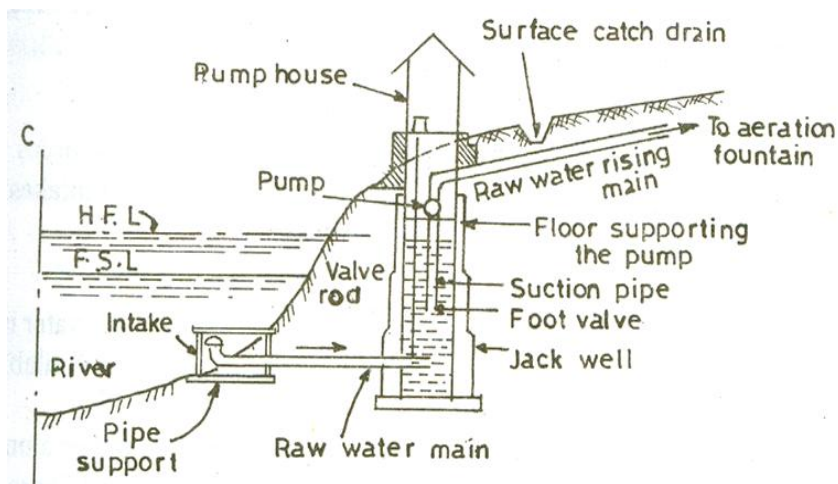

Fig. 4.1

#### Types of Intakes:-

Intakes are used to collect water for water works from various sources. The sources may be rivers , reservoirs , canals . Common type of intakes are :

- (i) River Intake
- (ii) Reservoir Intake
- (iii) Canal Intake

**River Intake** (Refer Fig. 4.2) :- It is a circular masonry tower constructed along the bank of river at such place from where required quantity of water can be obtained in the dry period . The water enters in the lower portion of the intake is known as the sump well from penstock. The penstocks are fitted with screens to check the entry of solid and are placed on the downstream side. The opening & closing of penstock valves is done with the help of wheels provided at the pump house floor.

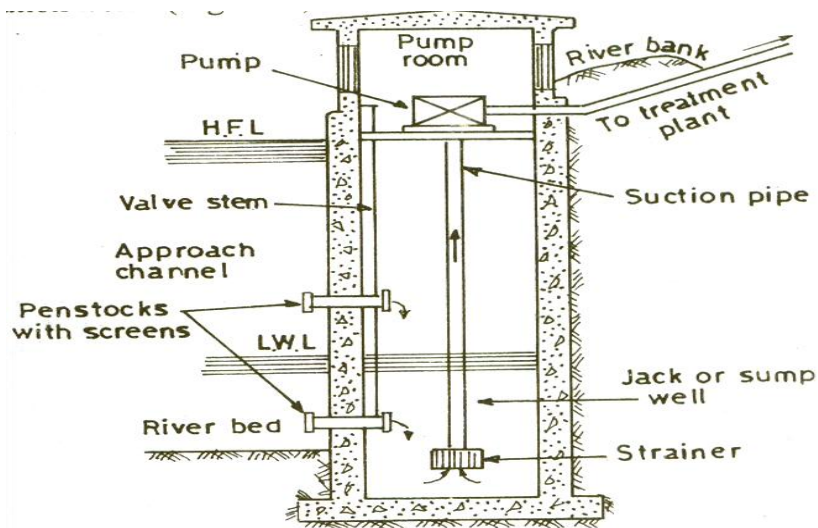

Fig. 4.2 (River Intake)

**Reservoir Intakes :-** These consists of intake towers having no water inside other than in the intake pipes. The interior of the tower is thus made available for inspection & operation . Fig. 4.3 shows a reservoir intake which is usually located either along the upstream of an earthen dam or within the body of a masonry dam. There are number of inlets protected by screen at different levels to draw in clear water from near the sources.

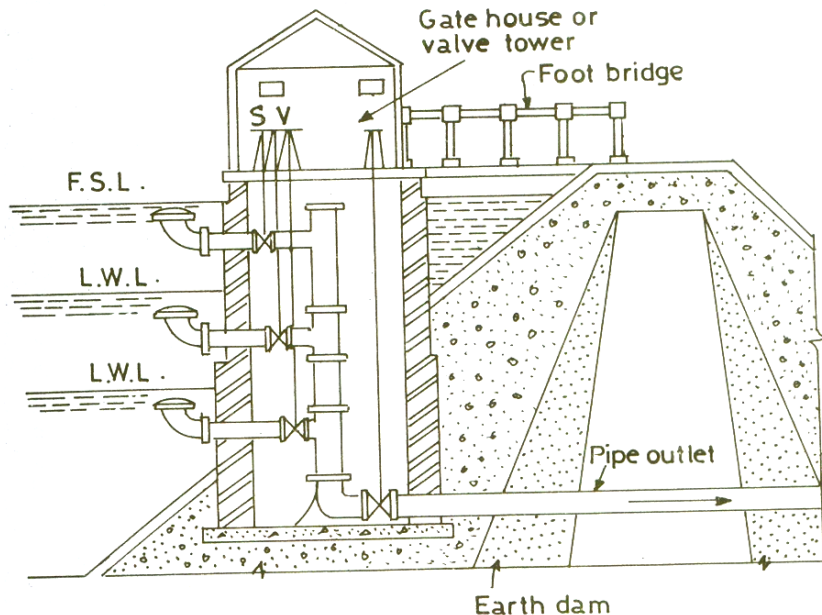

Fig. 4.3 (Reservoir Intake)

When the discharge of some river in summer remains sufficient to meet up the demand , but some rivers dry up partly or fully & can not meet the hot weather demand. In such cases reservoirs are constructed by constructing weirs or dams across the river.

**Canal Intake:-** Canal Intake is a very simple structure constructed on the bank of a canal & consists of a RCC or brick masonry chamber built partially in the canal bank. Fig 4.4 essentially shows a canal intake. It has a side opening fitted with coarse screen which excludes heavier matter from entering the conduit. The end of pipe inside chamber is provided with a bell mouth fitted with a hemispherical fine screen. The outlet pipe carries the water to the other side of the canal bank from where it is taken to the treatment plant.

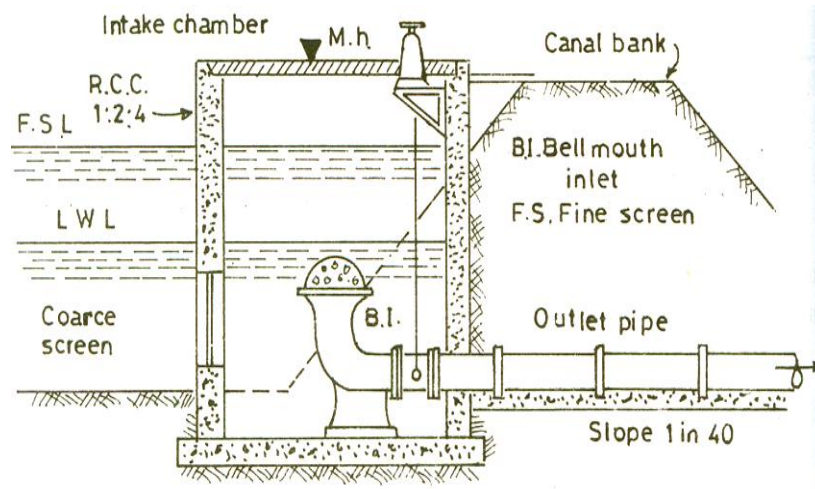

Fig. 4.4 (Canal Intake)

**PIPES :** These are circular conduits in which water flows under pressure .

Now a days the following types of pipes are available :-

- (i) Cast Iron Pipe
- (ii) Steel Pipe & Wrought Iron Pipe
- (iii) RCC Pipe
- (iv) Asbestos Cement Pipe
- (v) Polyvinyl Chloride Pipes

**Cast Iron Pipes :-** These are most commonly used in water supply scheme due to their durability, strength, resistance to corrosion, easy of laying etc . But the disadvantages of this type of pipes are:-

- (i) Due to its heavy weight, large diameter pipes are difficult to transport in hilly & difficult terrain.
- (ii) Coating inside and outside of the pipe is required for carrying corrosive water.

**Steel & Wrought Iron Pipes :-** These pipes are stronger than cast iron pipes. They are however less durable having life up to 50 years , more liable to corrosion. To increase the life

of wrought iron pipes sometimes these are galvanized with zinc. These pipes can withstand much higher pressure but are of lighter section & hence easy to transport to site .

**Advantages of Steel Pipes :-**

- (i) Steel Pipes are cheap.
- (ii) These pipes are more durable.
- (iii) These pipes are light in weight , hence easy to transport.
- (iv) These pipes are available in large lengths which decreases the number of joints
- (v) Steel pipes can resist high internal pressure.

**Disadvantages :-**

- (i) Steel pipes are likely to be rusted which reduces their life.
- (ii) These pipes require more time for repair.
- (iii) The maintenance cost is more.

**Reinforced Cement Concrete Pipes :-** These are very durable , heavier & can be used up to 1.8m diameter. Transportation costs are much reduced if the pipes are cast- in –situ. These pipes are resistant to corrosion & specially suitable for soft & acidic water. The concrete mix normally used is 1:2:2.

**Advantages :-**

- (i) These pipes have low maintenance cost.
- (ii) The pipes are not corroded from inside by normal drinkable water.
- (iii) These are very durable.

**Disadvantages :-**

- (i) These pipes are difficult to repair & join.
- (ii) The pipes have tendency to leak due to shrinkage cracks & porosity.
- (iii) The pipes are difficult to transport.

**Asbestos Cement Pipe :-** These are manufactured from a mixture of port land cement & asbestos fibre combined under pressure into a dense homogeneous structure. These pipes are very light in weight , can be easily cut, joined & handled. They resist corrosion & are very smooth. Use of these pipes are restricted to minor works of distribution system , because of poor structural resistance to bending stresses caused during transportation.

**Advantages :-**

- (i) The pipes are very light in weight.

- (ii) The pipes are smooth & their carrying capacities do not reduce with time.
- (iii) The pipes are very suitable as small distribution pipes.
- (iv) The pipes are flexible as such the joints are easily formed.

**Disadvantages :-**

- (i) The pipes are costly & less durable.
- (ii) The pipes are soft & brittle & do not have much strength.
- (iii) The pipes are likely to be damaged during transportation.

**PVC Pipes :-** These pipes are widely used for cold water services, rain water system etc. These are strong & can withstand much high pressure for a given wall thickness. It is quite resistance to salt water, corrosive fumes , corrosive soil etc.

**Selection of Pipe Material :-**

The factors which affect the selection of pipe materials are :

- (i) Internal pressure & external loads to which the pipe is subjected.
- (ii) Type of water to be conveyed & it's resistance to corrosion.
- (iii) Maintenance cost.
- (iv) Availability of fund.
- (v) Expected life & repair & replacement.

**PIPE JOINTS :-**

The common types of pipe joints are as follows :-

- (i) Spigot & socket Joint
- (ii) Flanged Joint
- (iii) Expansion Joint.
- (iv) Flexible Joint
- (v) Collar Joint
- (vi) Screwed & socket Joint

**Spigot & Socket joint** (Refer Fig. 4.5):- This type of joint is commonly used in case of cast-iron-pipes. For the construction of this joint the spigot or normal end of one pipe is centred into the socket of the other pipe. Hemp yarn is then wrapped around the spigot, leaving unfilled the required depth of socket for lead. A kneeled clay ring is then placed around the barrel & against the face of the socket. After this molten pig lead is poured into fill the remainder of the socket.



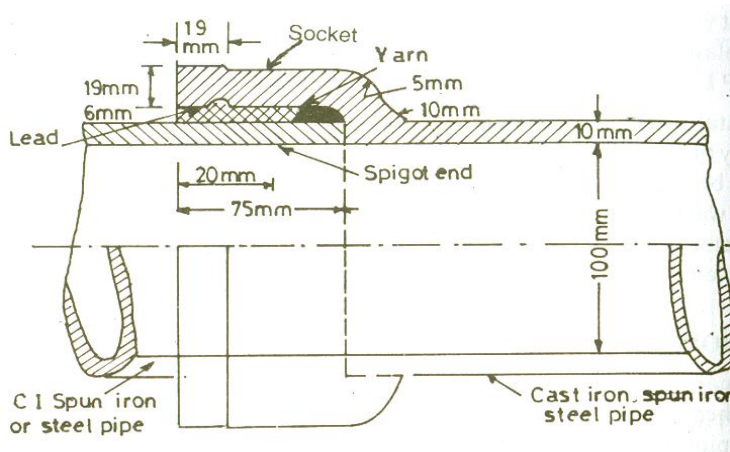

Fig. 4.5 (Spigot & Socket joint)

**Flanged Joint** (Refer Fig. 4.6) :- These joints are rigid & are easy to disjoin, as such used where pipe joints have to occasionally opened out for carrying out repair work as in pumping chamber. The pipe in this case has flanges on its both ends, casted, welded or screwed with the pipe. A gasket of rubber, canvass or lead is introduced between the two flange of cast iron pipes, which are then tightened with bolts & nuts.

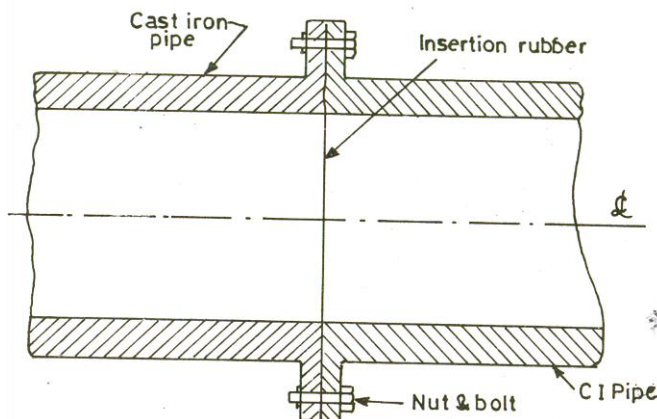

Fig. 4.6 (Flanged Joint)

**Expansion Joint** (Refer Fig. 4.7) :- These joints are used on pipes exposed to considerable differences of temperature allowing for free expansion or contraction without setting up thermal stresses in the pipes. Here when the pipe expands, the socket end moves forward & when pipe contracts, it moves back word in the space provided for it & the elastic rubber gasket in every position keeps the joint water tight.

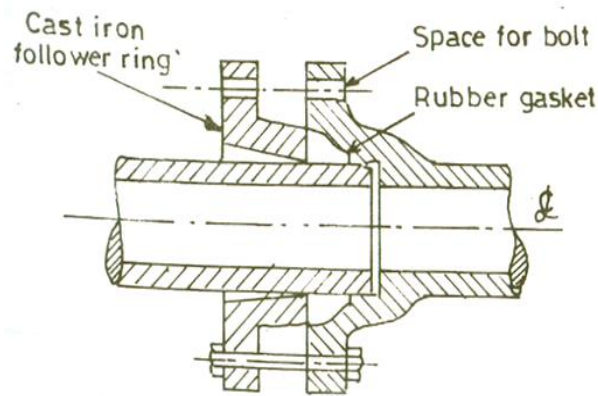

Fig. 4.7 (Expansion Joint)

**Flexible Joints** (Refer Fig. 4.8) :- These joints are used for pipes to be laid submerged under water, where the bottom of the river is uneven with the possibility of settlement & consequent damage. If one pipe is given any deflection, the ball shaped portion will move inside the socket, & the joint will remain water proof in all the position .

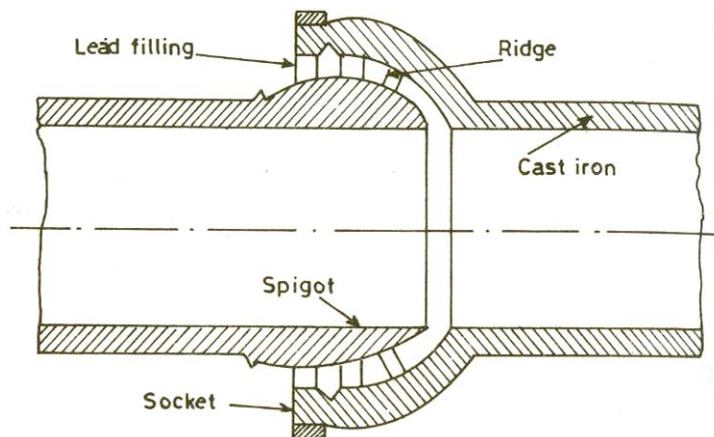

Fig. 4.8 (Flexible Joint)

**Collar Joint** (Refer Fig. 4.9) :- This joint is mostly used for joining concrete & Asbestos cement pipe having bigger diameter. A rubber gasket is placed between steel rings in the groove after bringing the ends of the two pipes in one level. Then the collar is placed at the joint so that it should have the same lap on both the pipes. After this cement mortar (1:1) is filled in the gap between the pipes & the collar.

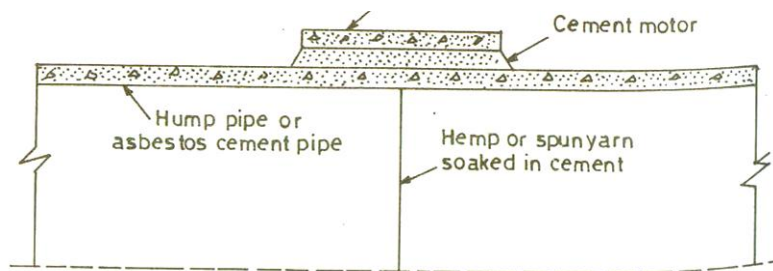

Fig. 4.9 (Collar Joint)

**Screwed & Socket Joints** (Refer Fig. 4.10) :- This is a simple type of joint commonly used for jointing screwed wrought iron or Galvanised iron pipes. In this joint, two ends of the pipes are threaded on the outside and on them a suitable jointing compound should be used before screwing socket over it having corresponding threads from inside.

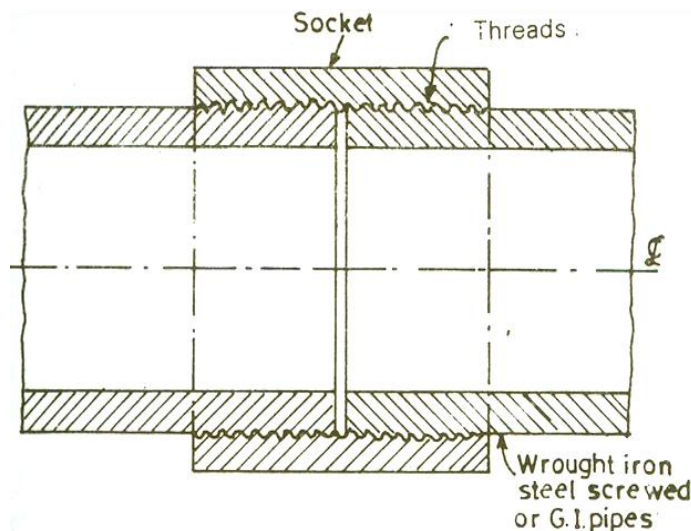

Fig. 4.10 (Screwed & Socket Joints)

### Laying of Pipes:-

Pipes are generally laid with a flat slope parallel to the hydraulic gradient to avoid any air locking trouble. Where there is slope, pipe laying should be done in an uphill direction to facilitate joint making.

### Testing of Pipe Lines:-

After a new pipe line has been laid & jointed, it shall be subjected to the following two tests :

- (i) Pressure Test
- (ii) Leakage Test

### Pressure Test at a Pressure at least double the maximum working Pressure:

The procedure adopted for pressure testing of pipes is as follows :-

- (i) The pipe line is tested from section to section. At a time only one section lying between two sluice valves is taken up for testing.
- (ii) First the downstream sluice valve of the section is closed & water is admitted in the section through the upstream sluice valve. During filling air valve is properly operated to remove all air from the pipe.
- (iii) Then the upstream valve is close to completely isolate the section from the rest of the pipe line.
- (iv) Pressure gauges are then fitted along the pipe length of the section at suitable interval (generally 100 mm or so) on the crown through holes left for this purpose.
- (v) The pipe section is then connected to the delivery side of a pump through a small by-pass valve & the pump is started to increase the pressure in the pipe. The operation is continued till the pressure inside the pipe reaches a pressure at least double of the maximum working pressure.
- (vi) The by-pass valve is then closed & the pump is discontinued .
- (vii) The pipe is kept as it is for 24 hours & inspected for any fall of pressure. This completes the pressure testing of pipes.

**Leakage Test at a Pressure to be specified by the authority :-**

After successfully completing The pressure test , the leakage test is carried out. Leakage Test is to test maximum allowable leakage which is determined by the formula :

$$Q = (NDP^{1/2})/3.3$$

Where  $Q$  = allowable leakage in  $\text{cm}^3/\text{hr}$

$N$  = number of joints in the length of pipe line

$D$  = diameter in mm

$P$  = the average test pressure during the leakage test in  $\text{kg}/\text{cm}^2$

**Causes of corrosion in water system pipes**

Pipes used to distribute drinking water are made of plastic, concrete, or metal (e.g., steel, galvanized steel, ductile iron, copper, or aluminium). Plastic and concrete pipes tend to be resistant to corrosion. Metal pipe corrosion is a continuous and variable process of ion release from the pipe into the water. Under certain environmental conditions, metal pipes can become corroded based on the properties of the pipe, the soil surrounding the pipe, the water

properties, and stray electric currents. When metal pipe corrosion occurs, it is a result of the electrochemical electron exchange resulting from the differential galvanic properties between metals, the ionic influences of solutions, aquatic buffering, or the solution pH.

**Remedies :-**

- Avoid placing of old pipes.
- Avoid placing of rust pipes.
- Control dissolved gases from water which flows through the pipes.
- Rust preventives like lubricants , greases, oils are used to form a protective film to prevent corrosion.

## CHAPTER-5

### QUALITY OF WATER

#### Impurities in water:-

For the purpose of classification the impurities present in water may be divided in to the following three categories.

1. Physical impurities
2. Chemical impurities
3. Bacteriological impurities

#### 1) **Physical impurities:-**

- a) **Colour:-**The water bodies may be receiving colour from natural and artificial sources. The discharge from many industries may be coloured and such discharge in to natural water bodies imparts colour to the water of such water bodies.

It may be noted that pollution of water due to colour is mainly an aesthetic one and in many cases, it does not develop any thread to the public health.

The measurement of colour in water is carried out by means of a tintometer. For public water supply' the number on cobalt scale should not exceed 20 and should be preferably less than 10.

- b) **Taste and odour:-**The eater possesses taste and odours due to various causes and they make the water unpleasant for drinking. The industrial wastes contain many strong smelling chemical compounds and when such trade wastes are discharged in to rivers or streams, the water of such rivers or streams gets unpleasant taste and odours. The taste and odour in water in general have no real public health significance. But the pollution of water by taste and odour has the following effects.

- (i) Such waters may prove detrimental to fish life and may damage the value of fisheries.
- (ii) Such waters are not liked by public and they are rejected even in preference to tasteless and odourless waters of poor quality.
- (iii) if taste and odour in water are due to certain toxic chemical gases, the use of such water may seriously injure the public health.

The test is carried out by in having through tests of an osmoscope. The taste and odour of water may also be tasted by thresholds number. For public water supply the threshold number should not be more than that.

- c) **Temperature:** - If the temperature of trade wastes which are discharged in to rivers or streams is high, their bodies. For instance, the cooling water from thermal and nuclear power statuses is considerably warm and if such warm water is discharged in to natural water bodies, it will result in the rise of temperature of water of such natural bodies.

The test for temperature of water has no practical meaning in the sense that it is not possible to give any treatment to control the temperature in any water supply project. The temperature of water to be supplied from storage reservoir depends on the depth from which it is drawn. The desirable temperature of potable water is 10°C while temperature of 25°C is considered to be objectionable.

The measurement of temperature of water is done with the help of ordinary thermometer. From the study of temperature the characteristics of water such as density, viscosity vapors pressure and surface tension can be determined. It also helps in determining the saturation values of solids and gases which can be dissolved in water and also the rates of chemical, biochemical and biological activity.

- d) **Turbidity:-** The colloidal matter present in water interferes with passage of light and thus imparts turbidity to the water. The turbidity in water may also be due to clay and silt particles, discharges of sewage or industrial wastes, presence of large numbers of microorganisms etc. And the cloudy appearance developed in water due to turbidity is aesthetically unattractive and it may also be harmful to the consumers. Turbidity disturbs the disinfection process because the solids may practically shield the organics from the disinfectant.

The turbidity is expressed in terms of parts of suspended matter per million parts of water or shortly written as P.P.M. It is to be noted that the expression p.p.m is also equivalent to mg per liter. or mg/ltr. The standard units of turbidity are the turbidity produced by one part of filter earth which is in the form of finely divided silica in a million parts of distilled water. The permissible turbidity for drinking water is 5 to 10 p.p.m.

The measurement of turbidity in the field is done by means of turbidity rod and it is referred to as the visual method of turbidity measurement for lab, turbidity meters are used for to measure the turbidity of water.

The data obtained from turbidity measurements are helpful in the following ways.

- i. It assists in deciding whether turbidity interferes with the photosynthesis reaction in streams and lakes.
- ii. It gives indicator of the quantity of chemicals required for day to day operators of water treatment works. The excess turbidity may seriously affect the functioning of slow sand filters.

#### **Chemical impurities and chemical tests: -**

- 1) **Chlorides:-**The chloride contains especially of sodium chloride or salt, are workout for a sample of water. The excess presence of sodium chloride in natural water indicate pollution of water due to sewage, minerals, edible oil, mill separators, ice-cream plant effluents, chemical industries, sea water intrusion in costal regions etc. For portable water, the highest desirable level of chloride content is 25mg/ltr. And its maximum permissible limit is 600mg/ltr.

The presence of chlorides can corrode and such water cannot be used for boilers because of formation HCl due to presence of magnesium chloride in water.

- 2) **Dissolved gasses:-**The water contains various gasses from its contact with the atmosphere and ground surfaces. The usual gasses are nitrogen, methyl hydrogen sulphide,  $CO_2$  and oxygen. The contents of these dissolved gasses in a sample of water are suitably worked out.

The Nitrogen is not very important the methane concentration is to be studied for its explosive property. The hydrogen sulphide gives disagreeable odour to the water even if its amount is very small. The carbon dioxide content indicates biological activities causes' corrosion, increases the solubility of many minerals in water and gives taste to the water.

The oxygen in the dissolved state is obtained from atmosphere and pure natural surface water is usually saturated with it. The simple test to determine the amount of dissolved oxygen present in a sample of water is to expose water for 4 hours at a temperature of 27°C with 10% acid solution of potassium permanganate.



The quantity of oxygen observed can then be calculated. This amount for portable water should be about 5 to 10 p.p.m.

- 3) **Hardness:-**The term hardness is defined as the ability of the water to cause precipitation of insoluble calcium and magnesium salts. Of higher fatty acids from soap.

The hardness or soap destroying power of water is of two types- Temporary hardness and permanent hardness.

The temporary hardness is also known as the carbonate hardness and it is mainly due to the presence of bicarbonate of calcium and magnesium. It can be removed by boiling or by adding lime to the water.

The permanent hardness is also known as the non carbonate hardness and it is due to the presence of sulphates, chlorides and nitrates of calcium and magnesium. It cannot be removed by simply boiling the water. It requires special treatment of water softening.

The excess hardness of water is undesirable because of various reasons such as it causes more consumption of soap, affects the working of dyeing system, provides scales on boilers, causes corrosion and inner staining of pipes, makes food tasteless etc.

The hardness is expressed as per Clark's scale in terms of degree of hardness. Thus one grain of  $CaCO_3$  dissolved in one gallon of water will produce one degree of hardness. The expression p.p.m. is used to mean mg per liter and in that case, one degree of hardness will be equal to 14.5 p.p.m. It is found that each degree of hardness causes wastage of about 0.60 gram of soap.

The water having hardness of about 5 degrees is reasonably soft water and a very soft water is tasteless. Hence for portable water, the hardness should preferably be more than 5 degrees and less than 8 degrees or so.

- 4) **Hydrogen-ion concentration( pH value) :-**

The acidity or alkalinity of water is measured in terms of its pH value or H-ion concentration.

The pure water ( $H_2O$ ) consists of positively charged hydrogen or H-ions combined with negatively charged hydroxyl or OH-ions. But the process of dissociation takes place in pure water and hence it contains some uncombined positively charged H-ions and some uncombined negatively charged OH-ions. The water becomes acidic when positively charged H-ions are in excess than negatively charged OH-ions and it becomes alkaline when reverse is the case.

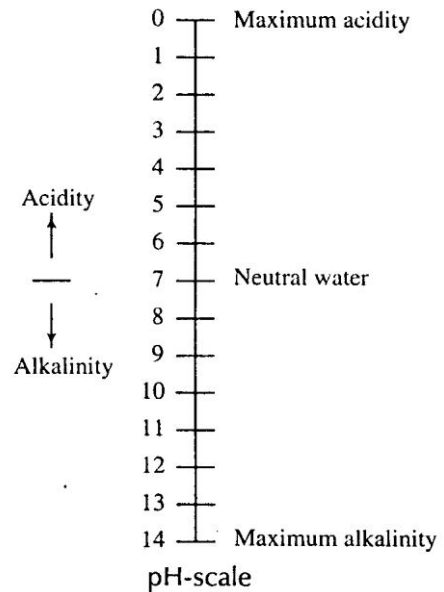

Fig.5.1

Fig. (5.1) shows pH scale. Neutral water has pH value of 7. As pH value becomes less, the water becomes acidic and when pH value is zero it indicates maximum acidity similarly the water becomes alkaline as pH values at increase and maximum alkalinity is indicated when pH value is equal to 14.

- ❖ It is desirable to maintain pH value of water very close to 7. The acidic water causes tuberculation and the alkaline water causes incrustation.
  - ❖ For portable water, the pH value should be between 6.5 and 8.5.
- 5) **Alkalinity**:-The term alkalinity with reference to the water and waste water is defined as the capacity of substance contained in the water to take up hydronium ( $H_3O^+$ ) to reach a defined pH value 4.3 to 14.
- ❖ The alkalinity is due to the presence of bicarbonate ( $HCO_3^-$ ), carbonate ( $CO_3^{--}$ ) or hydroxide ( $OH^-$ ).
  - ❖ The alkalinity is usually divided into the following two parts.
    1. Total alkalinity i.e., above pH 4.5
    2. Caustic alkalinity i.e. above pH 8.2
  - ❖ The alkalinity is measured by the volumetric analysis. The various types of indicators are available for this purpose the commonly adopted two indicators are as follows.

1. Phenolphthalein pink above pH 8.2 and colorless below pH 8.2.
  2. Methyl orange: Red below pH 4.5 and yellow orange above pH 4.5
- ❖ The excess alkalinity is harmful for irrigation which leads to the soil damage and reduce crop yields.
  - ❖ The highly alkaline water is usually unpalatable.
  - ❖ The large amount of alkalinity imparts a bitter taste to the water.
  - ❖ The water having alkalinity less than 250 mg/ltr. Is desirable for domestic consumption and for R.C.C construction.
- 6) **Acidity:-**The term acidity with reference to the water and waste water is defined as the capacity of substance contained in water to take up Hydroxyl ions ( $OH^-$ ) to reach a defined pH value ( 0 to 8.2)
- ❖ The acidity are of the following two types.
    1. Carbon dioxide acidity: This acidity is due to the presence of  $CO_2$  in ground water and surface water.
    2. Mineral acidity: The mineral acidity is due to the presence of HCl,  $H_2SO_4$ ,  $HNO_3$  and strong organic acids.
  - ❖ Total acidity ( as  $CaCO_3$ ) = Mineral acidity +  $CO_2$  acidity.
  - ❖ The determination of acidity of water has got significance because of the following reasons.
    1. It affects the aquatic life.
    2. It affects the biological treatment of sewage.
    3. It corrodes pipes.
    4. The water having acidity more than 50mg/ ltr. Cannot be used for R.C.C construction.
- 7) **Metal and other chemical substances:** - Various tests are made to detect the presence of different metals and other chemical substance in a sample of water.

Name of metal	Maximum permissible concentration in mg/ ltr
Arsenic ( $A_s$ )	0.05
Copper (Cu)	1.00
Fluoride(F)	1.70
Iron (Fe)	0.30
Zinc(Zn)	5.00

8) **Nitrogen and its compounds:** -The nitrogen is present in water in the following four forms

1. Free ammonia
2. Albuminoid ammonia
3. Nitrites
4. Nitrates

- ❖ The amount of free ammonia in portable water should not be exceeded 0.15 p.p.m. and that of albuminoid ammonia should not exceed 0.3 p.p.m.
- ❖ The term albuminoid ammonia is used to represent the quantity of nitrogen present in water before the decomposition of organic matter has started.
- ❖ The presence of nitrides indicates that the organic matter present in water is not fully oxidized or in other words, it indicates an intermediate oxidation stage. The amount of nitrites in portable water should be nil.
- ❖ The presence of nitrated indicates that the organic matter present in water is fully oxidized and the water is no longer harmful. For portable water, the highest desirable level of nitrates is 45mg/ltr.

9) **Total solids:-** The term solids with reference to the environmental engineering is defined as the residue in water left after evaporation and drying in oven at 703°C. The total solids consist of dissolved and suspended matter.

**1. Dissolved solids:-** In natural water the dissolved solids mainly consists of inorganic salts like carbonates, bicarbonates, chlorides, sulphates, etc. Together with small amounts of organic matter and dissolved gases.

- ❖ For measuring the total dissolved solids, the sample of water is placed in a clean porcelain dish and it is ignited in muffle furnace. After partial cooling in the air, it is cooled in a desiccator and is weighed. Then, total dissolved solids

$$\text{in mg/ltr} = \frac{A-B}{V} \times 1000$$

Where

A= Final weights of the dish

B= Initial in mg weight of the dish in mg.

V= volume of sample in ml.

- ❖ Many dissolved substances are undesirable in water and they impart displeasing color, taste and odour.
  - ❖ The water with higher content of the dissolved solids has laxative or sometimes reverse effect on the human body and it takes time for people to adjust with such water.
  - ❖ In a similar way the high concentration of dissolved solids say 3000 P.P.M may also produce disease in livestock and many lead to scaling boilers corrosion, etc.
  - ❖ The estimation of total dissolved solids is useful in determining the suitability of water for drinking purpose as well as for agriculture and industrial processes.
  - ❖ The permissible total dissolved solids for drinking water according to BIS is 500mg/ltr. With tolerable limit as 1500mg/ ltr.
2. **Suspended solids:** - In surface water the suspended solids consists of inorganic matter like silt and organic matter like algae. These materials are generally carried by erosive action of the flowing water over land.
- ❖ For measuring suspended solids the water is filtered through a fine filter and dry material retained on the filter is weighed. The drying is carried out for one hour in an oven at 105°C
- Then total suspended solids in mg/ltr =  $\frac{W_2 - W_1}{V} \times 1000$
- Where W1 = Initial weight in mg.  
W2 = Weight of dry material retained on filter in mg.  
V = Volume of sample in ml.
- ❖ The suspended matter is objectionable in water for following reasons
    - I. It is aesthetically displeasing
    - II. It may include disease causing organisms.
    - III. It may release objectionable odours
    - IV. It provides absorption sites for chemical and biological agents.
  - ❖ The estimation of total suspended solids is extremely useful in the analysis of polluted water and for evaluating the efficiency of treatment units.

**SAMPLING:-**Sampling is the most important part of any analysis because the final result obtained even from the most accurate analysis will be misleading if the sample on which such analysis is carried out are not representative ones of the liquids to be tested. As a matter of fact it will be idle to carry out all the analysis immediately after the collection of samples and the quicker the analysis the more representative will be the results of analysis of the liquid.

**Precautions to be taken while collecting the samples of water to be analyzed:-**

- I. The water should be collected in bottles, especially of white glass having well fitted stoppers. The bottles having holding capacity of about 2 litres of water are necessary for the chemical analysis.
- II. The bottle should be thoroughly cleaned, filled thrice with water and thrice with emptied before collecting the sample. However it will not be necessary to carry out such process if the sealed bottles are directly obtained from the laboratories.
- III. When the sample of water is to be collected from a pipe the water tap should be turned on and the water should be allowed to go waste for at least two minutes to prevent the entry of impurities of the pipe in the sample of water.
- IV. For collecting the sample of water from lake, stream, spring or well, the whole bottle with stopper enclosed should be suspended well under the surface of water and then only the stopper of bottle should be removed by means of a clean piece of string and the bottle is filled thus the entry of floating minerals will be prevented in the bottle.
- V. The bottle should be held as far away from its neck as possible. In no case the water entering the bottle should come in contact with the hand.
- VI. After collecting the sample the stopper of the bottle should be well secured and the bottles containing samples of water should be level starting the source date and time of collection.

**BACTERIOLOGICAL TESTS: -**

- The examination of water for the presence of bacteria is very important. The bacteria are very small organisms and it is not possible to detect them by microscope. Hence they are detected by circumstantial evidence or chemical reactions.
- The bacteria may be harmless to mankind or harmful to mankind. The former category is known as the non pathogenic bacteria and the latter category is known as pathogenic bacteria.

- The combined group of pathogenic and non pathogenic bacteria is designated by bacillus coli (bacillus- bacterium coli = intestine) or B-coli group. This group of bacteria is present in intestines of living warm-blooded animals.

**Following are the two standard bacteriological tests for the bacteriological examination**

**of water:**

- (1) Total count or agar plate count test.
- (2) B-coli test.

**(1) Total count or agar plate count test:**

\*In this test, the bacteria are cultivated on specially prepared medium of agar for different dilution of sample of water with sterilized water.

\*The diluted sample is placed in an incubator for 24 hours at 37° c (I.e. blood heat) or 48hours at 20°c. These represent the so called hot count and clod counts respectively .The bacterial colonies which are formed, are then counted and the results are computed for i.e. For potable water, the total count should not exceed 100 per c.c.

**(2) B-coil test:** This test is divided into the following three parts:

- (i) Presumptive test.
- (ii) Confirmed test.
- (iii) Completed test

**Presumptive test:** following procedure is adopted in this test:

(a) The definite amount of diluted sample of waters are taken in multiples often, such as 0.1c.c., 1.0 c.c., 10 c.c. etc.

(b) The water placed in standard fermentation tubes containing lactose broth.

© The tube is maintained at a temperature of 37°c for a period of 48hr.

(d) If gas is seen in the tube after this period is over, it indicates presence of B -coil group and the result of the test is treated as +ve . If reverses is the case, it indicate absence of B-coil group and the result of the test is treated as negative .

(d) A negative result of presumptive test indicates that water is fit for drinking.

### **Confirmed test:**

This test is carried out in the following ways:

(a) A small portion of lactose both showing positive presumptive test is carefully transferred to another fermentation tube containing brilliant green lactose bile, if gas is seen in the completed test become essential.

(b) A small portion of material showing positive presumptive test is made on the plates containing Endo or eosin-methylene-blue agar. The plates are kept at 37°C for 24 hrs. If colonies of bacteria are seen after this period, it indicates positive result and the competitive test becomes essential. The colonies are prominent by metalize brightness and dark spots.

### **(iii) Completed test :**

\*This test is made by inoculating bacteria colonies into lactose broth fermentation tubes and agar tubes. The incubation is carried out at 37°C for 24 to 48 hours. If gas is seen after this period, it indicates positive result and further detailed test are carried out to detect the particular type of bacteria present in water. The absence of gas indicates negative result and the water is considered safe for drinking.

### **Sedimentation tanks:**

- Having examined the quality of water a line of treatment is to be recommended for impure water to make it potable or fit for drinking purpose.
- The first stage of treatment is the precipitation of water and is intrudes provision of sedimentation tank or settling tanks or clarifier. These tanks remove inorganic impurities and make water fit for the next process of filtration.
- The sedimentation tanks are designed to give complete rest to the flowing water is allowed to flow at a very low velocity. The actual amount of matter removed by sedimentation tanks depends on several factors such as design of tank, detention period, size of suspended particles, velocity of the flow, etc.,

It is estimated that plain sedimentation tanks can remove about 60% of suspended matter and about 75% of bacteria load from water. \*In order to make the sedimentation tanks effective the coagulants are added to the water before it is brought to the sedimentation tanks. \*The sedimentation tanks are located near filter units and in case of variations in demand, they may ever be called upon to work as storage reservoirs where filtration is to be adopted it is essential to provide the sedimentation tanks.



## CHAPTER-6

### TREATMENT OF WATER

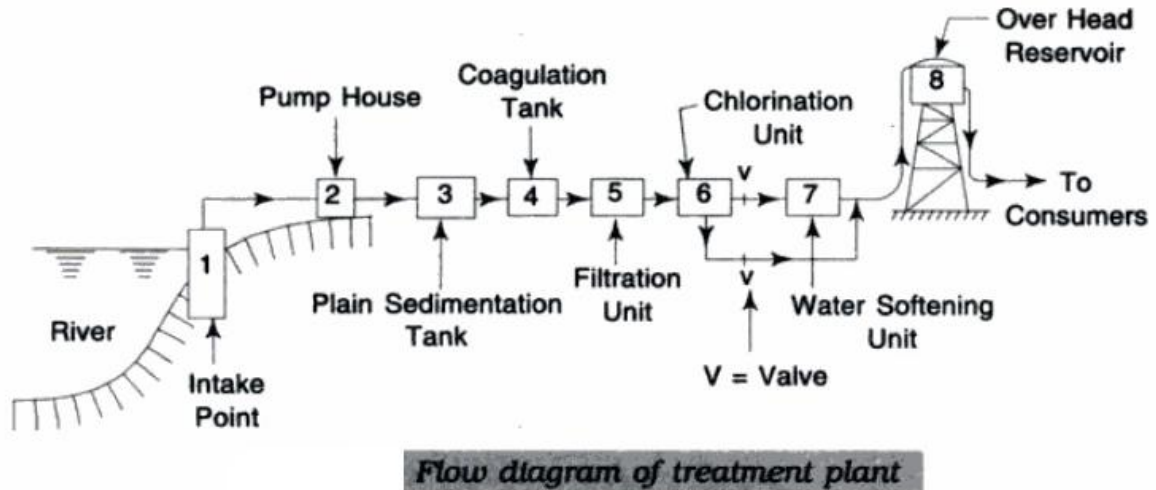

**Fig.6.1**

#### TYPES OF SEDIMENTATION TANKS (CLARIFIERS)

Depending upon the nature of working, clarifiers are of the following two types:

- (1) Fill and draws type clarifies.
- (2) Continuous flow type clarifies.

##### (1) Fill & draw a type clarifies:

**(i) Working:** These are also known as the quiescent type or intermittent type clarifiers. The working of tanks is simple. The water is filled in the tank and it is then allowed to rest for a certain time. During the period of rest the particles in suspensions will settle down at the bottom of the tank. The clear water is then drawn off and the tank is cleared of silt and filled again.

The usual period of rest to cause settlement of particles is about 24 hours or so. If time is required for inlet, outlet, emptying and clearing portion is added a period about 30 to 36 hours is required to put the tank again in working condition.

This means that the least two tanks will be required if an additional unit is to be provided as stand by, the minimum number of tanks required under this type of working will not be less than three.

##### (iii) Design consideration:

- The cubical contents of the tanks will represent the storage capacity of the tank. The provision is made at the bottom for accumulation of still. The outlet valve is provided at

the top of still deposit zone .the inlet and outlet for water are arranged at opposite ends as seen in plan of the tank fig.1 shows the plan section of a typically fill and draw type clarifier.

• **USE:**

\*These tanks are mostly out of the use at present as they process many disadvantages.

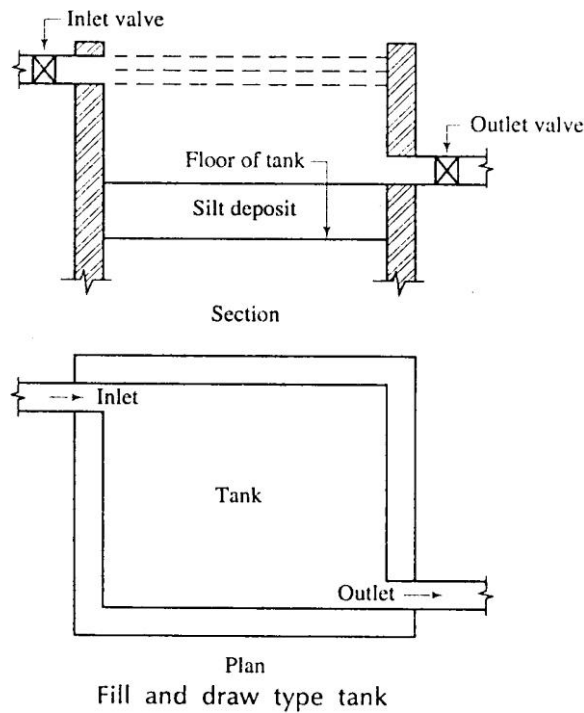

Fig.6.2

(i)If velocity of the flow is reduced a large amount of suspended impurities from water can be easily removed .This is the principle on which continuous floe type of sedimentation tanks is working.

\*The working operation of the tank is very simply as illustrated in fig2.The water enter the tank from one end as it travels towards the out let at the other end, its velocity is broken and radiuses by means of bottle walls. The walls contain opening at di8ffriencer level.

\*The velocity of the flow is so adjusted that the time taken by a particle of the water to move from one end to other is slightly move then that require d for the settlement of suspended impurities in water.

\*The entry of impure water from one end the exit of clear water from the other end are continuous .The flows of water is designed to meet the following two requirement .

(a) The velocity of flows is such that suspend impurities of require size settle down at the bottom clarifier.

(b) The total amount of flow from the tank within 24 hours equals to the daily demand of the water.

- The silt is deposited at the bottom of clarifiers and when it is accumulated in sufficient quantity, the flush valve is opened and the clarifier is cleaned.

(ii) USE: These clarifiers are widely used in the modern times as they possess many advantages as mentioned below.

(a) Less labor & supervision:

The action of the sedimentation tank is continuous and hence, no manual labour is required except at the time of cleaning or washing the clarifier. Also only general supervision is required during the working of the clarifier.

**(b) LITTLE LOSS OF HEAD:**

\*The outlet is situated near top of clarifier; there is practically very little loss of head. Also the pure water is drawn from the top level.

**(c) TANKS IN SERIES :**

\*The continuous tanks are arranged in series and hence any one of them may be isolated for cleaning or washing per se. Thus the provision of area for stand by units works out to be comparatively less.

**(d) TIME OF OPERATION:** As the flow of water is continuous, there is no wastage of time, once the tank is put into commission further, no clean water storage tanks will be required and this will result in reduction in cost.

**(IV) DISADVANTAGE:**

\*There is an only one major disadvantage of continuous flows type of clarifiers when the cleaned water in the tanks is to be taken out. Thus there is considerable wastage of water. But cleaning operation are not carried out frequently. Hence such wastage of water can be tolerated.

**SEDIMENTATION WITH COAGULATION:**

\*The turbidity is mainly due to the presence of very fine particles of clay still and organic matter.

\* All these impurities are in a finely divided state & it is not possible to detain them in plain sedimentation tanks unless such tanks are designed longer detention period.

\*The other alternative to remove such particles is to increase their size so that they become settleable. The purpose of coagulation is thus to make particles of bigger size by adding certain chemicals known as coagulants to the water. The coagulants react with the impurities in water and convert them in settleable size.

\*The coagulation is to be adopted when turbidity of water exceeds about 40ppm.

### **PRINCIPLES OF COAGULATION:**

The principle of coagulation can be explained from following two considerations.

**(1)Floc formation:** When coagulants are dissolved in water and thoroughly mixed with it. They produced a thick gelatinous precipitate. This precipitate is known as the floc and thus floc has got property of arresting the suspended impurities in water during its downward travels towards the bottom of the tank.

**(2) Electric charges:** The ions of floc are found to possess positive electric charge. Hence they will attract the negatively charged colloidal particles of clay and thus they caused the removal of such particle from the water.

\*The surface of floc is sufficiently wide to arrest colloid and organic matter present in water. The term flocculation is used to denote the process of flock formation and thus the formation and thus the flocculation follows the addition of coagulants and its efficiency depends on the

### **USUAL COAGULANTS :**

Following six are the usual coagulants which are adopted for coagulants :

- (1)Aluminum sulphate.
- (2)Chlorinated coppers.
- (3)Ferrous sulphate &lime.
- (4)Magnesium carbonate.
- (5)Polyelectrolyte
- (6)Sodium aluminate.

### **(1)ALUMINIUM SULPHATE:**

- This is known as the filter alum or alum only. Its chemical composition is  $Al_2(SO_4)_3 \cdot 18H_2O$ .
- The alum in water treatment practice is commonly supplied and used in the form of flawless or solid lumps and then applied in a solution form.

The advantages of using alum as a coagulant are as follows.

- i. It also reduces taste and odour in water.

- ii. It is cheap.
- iii. It produces crystal clear water

Generally the bicarbonate alkalinity is present in water and the chemical reaction involved between bicarbonate alkalinity and alum is as follows:

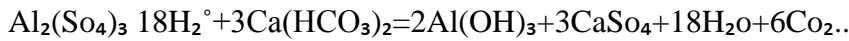

The aluminum hydroxide formed is insoluble in water and it behaves as folic.

If water possesses a little or no alkalinity, the lime is added to water. The chemical reaction is as follows.  $\text{Al}_2(\text{SO}_4)_3 \cdot 18\text{H}_2\text{O} + 3\text{Ca}(\text{OH})_2 = 2\text{Al}(\text{OH})_3 + 3\text{CaSO}_4 + 18\text{H}_2\text{O}$

This coagulant is found to be effective between PH range of 6.5 to 8.5.

In practices the dosage of alum varies from 5 to 30 milligrams per litre for normal water the usual being 14 milligrams per lit.

The disadvantages of using alum as a coagulant are mainly two.

It is difficult to dewater the sludge formed and further, it is not easy to distance it off also as it is found unsuitable for filling of lying lands.

The effective PH range for coagulation with alum is found to be too small and in some cases, the lime or caustic soda will have to be added to adjust the PH value at a proper level. This will increase the cost of treatment of water.

## (2) CHLORINATED COPPERAS:-

❖ When chlorine and solution of ferrous sulphate are mixed, the following chemical reaction takes place.  $6\text{FeSO}_4 \cdot 7\text{H}_2\text{O} + 3\text{Cl}_2 = 2\text{Fe}_2(\text{SO}_4)_3 + 2\text{FeCl}_3 + 42\text{H}_2\text{O}$

❖ The combination of ferric sulphate  $\text{Fe}_2(\text{SO}_4)_3$  and Ferric chloride is known as the chlorinated coppers, each one of the compound is effective as a flock and the combination is also quite effective.

❖ The ferric sulphate and ferric chloride  $\text{FeCl}_3$  both can be used independently with lime to act as coagulant and the chemical reactions involved would be as follows.

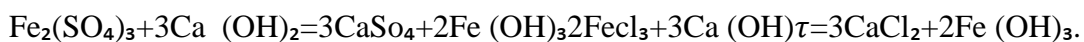

The ferric hydroxide  $\text{Fe}(\text{OH})_3$  forms the flock. For ferric sulphate, the effective PH change is 4 to 7 and above 9. For ferric chloride, the effective PH range is 3.50 to 6.50 and above 8.05.

**(3) FERROUS SULPHATE AND LIME:-**

❖ When ferrous sulphate and lime are added to the water, the following chemical reaction takes place.  $FeSO_4 \cdot 7H_2O + Ca(OH)_2 = Fe(OH)_2 + CaSO_4 + 7H_2O$ .

❖ The ferrous hydroxide  $Fe(OH)_2$  thus oxygen in water and ferric hydroxide is formed as per the following chemical reaction.  $4Fe(OH)_2 + 2H_2O = 4Fe(OH)_3$ .

❖ The ferric hydroxide  $Fe(OH)_3$  forms the flock. For ferrous sulphate, the effective PH range is 8.50 and above.

**(4) MAGNESIUM CARBONATE:-**

❖ When magnesium carbonate is dissolved and is mixed with water along with lime the following reaction takes place.  $MgCO_3 + Ca(OH)_2 = Mg(OH)_2 + CaCO_3$ .

❖ The compounds magnesium hydroxide  $Mg(OH)_2$  and calcium carbonate are insoluble in water and the sludge formed in this process contains a sludge of  $Mg(OH)_2$  and  $CaCO_3$ . This coagulant is not at present flavored.

**(5) Polyelectrolyte's:-**

❖ These are special types of polymers and depending upon the charge they carry, they are classified as anionic, cationic and nonionic only cationic polyelectrolyte's can be used effectively as independent coagulants. The others varieties can be used along with alum or other conventional coagulants.

❖ The use of polyelectrolytes is still in pilot stage and they may prove to be an alternative to the alum in future.

**(6) SODIUM ALUMINATE:-**

❖ The chemical composition of this coagulant is  $Na_2Al_2O_4 + Ca(HCO_3)_2 = CaNa_2Na_2Al_2O_4 + Na_2CO_3 + CO_2 + H_2O \rightarrow (1)$



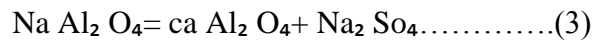

❖ This coagulant<sup>5</sup> removes carbonate or tempers or hardness as seen from equation 910 and it also removes non-carbonate or permanent hardness as seen from equation (2) and (3). The effective range of PH value for this coagulant is 6 to 8.5. This coagulant is costly and hence it cannot be adopted for treating water on a large scale.

**FLASH MIXERS:-**

Flash mixture are used to achieve quickly mixing and then the transfer water from the flash mixture to the slow mixture known as floe water.

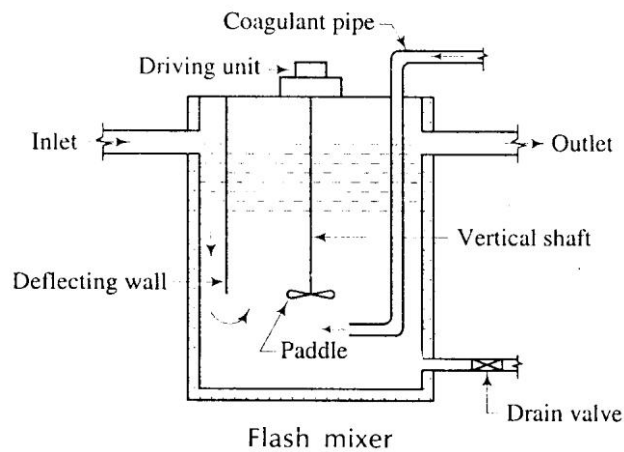

Fig.6.3

Fig.6.3. shows a typical flash mixer .The mixing is achieved by a rotating paddle situated at the lower end of the vertical shaft. The incoming water is deflected toward the moving paddle by deflecting wall.

- ❖ The coagulants are brought by coagulant pipe and also discharge just near the rotating fan.
- ❖ Adriane valve is providing to remove sludge from the bottom of flash mixture.

Figure below shows a typical flocculator. The slow mixing is achieved by rotating paddles. The paddles usually make about 2 to 3 revolts per minute.

## FILTRATION

### NECESSITY:

- ❖ The sedimentation tanks remove a large percentage of the suspended solids and the organic matter present in raw water.
- ❖ The process of coagulation further assists in the removal of impurities present in the water. But even then; the resultant water is not pure and may contain some very fine suspended particles, bacteria etc.
- ❖ In order to remove or to reduce the content of impurities still further, the water is filtered through the beds of fine granular material like sand. The process of passing through the bed such granular material is known as filtration.

### PRINCIPLES OF FILTERATIONS:

Process of filtration consists of the allowing water to pass through a thick layer of sand.

#### Principles of filtration are:

(1) **Mechanical straining:** The suspended particles which are unable to pass through the voids of sand grains are arrested and are removed by mechanical straining.

(2) **Sedimentation:** The voids between sand grains of filter act more or less like small sedimentation tanks. The particles of impurities arrested in these voids, adhere to the particles of sand grains and are removed by the action of sedimentation.

#### (3) **Biological metabolism:**

- ❖ The growth and life process of the living cells is known as the biological metabolism.
- ❖ When the bacteria are caught in the voids of sand grains, a zoological jelly or film is formed around the sand grains. This film contains large colonies of living bacteria. The bacteria feeds on the organic impurities contained in water. They convert such impurities into harmless compounds by the complex biochemical reaction.

(4) **Electrolytic changes:** According to this theory when two substances with opposite electric charges are brought in to contact with each other, the electric charges are neutralized and in doing so, new chemical substances are formed.

It is observed that some of the sand grains of filter are charged with electricity of some polarity. Hence, when particles of suspended and dissolved matter contain electricity



of opposite polarity come into contact with such sand grains they neutral each other and neutralize result in the alteration of chemical characteristics of water.

**CLASSIFICATION OF FILTERS :**

The filters are classified in to the following:

- (1) Slow sand filter
- (2) Rapid sand flitter.

The rapid sand filters are further subdivided into the following two categories.

- ❖ Gravity types rapid sand filter.
- ❖ Pressure type rapid sand filter.

The above classification is based on the rate of filtration .On the consideration of the gravity and pressure the filters may be classified as follows.

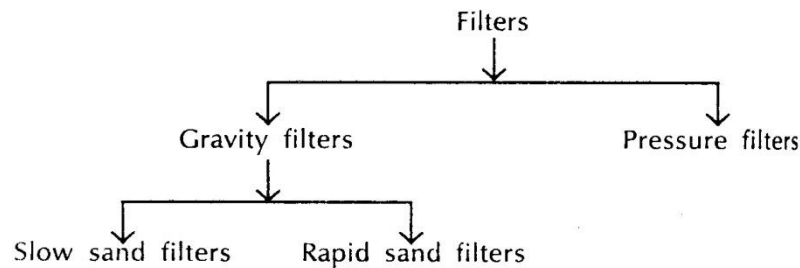

Combining the above two classification, there are following three types of filters.

- 1) slow sand filter
- 2) Rapid sand filter
- 3) pressure filter

**SLOW SAND FILTERS:**

- ❖ **(1)PURPOSE :** Incase of slow sand filtration , the water is allowed to pass slowly through a layer of sand placed above the base of the ,material and thus the purification process are at simultaneously improving the biological chemical and physical characteristic of water.
- ❖ The slow sand filtration is very well suited for rural are as in developing countries because of its simple operation and maintains procedure s. It thus provides safe drinking water at low recurrent cost.

**ESSENTIAL PARTS:** A slows sand filter consist of the following five parts.

- (1) Enclosure tank

(2) Under drainage system

(3) Base material

(4) Filter media or sand

(5) Appurtenances.

❖ **ENCLOSURE TANK:** A water tight tank is constructed either in stone masonry or brick masonry .The sides & floor are also coated with water proof material . The bed slope is about 1 in 100 to 1 in 200 towards the central drain. The depth of tank is about 2.50m to 3.50m .The surface area of a slow sand filter may vary from 30m to 2000m or even more

❖ **UNDER DRAINAGE SYSTEM:** The under drainage system consists of a central drain and lateral drain as shown in the fig. 6.4

The lateral drain is placed at a distance of about 2.5 m to 3.5m and they are stopped at a distance of about 500mm to 800mm from the walls of the tanks. The drains may be pipes which are laid with open joint.

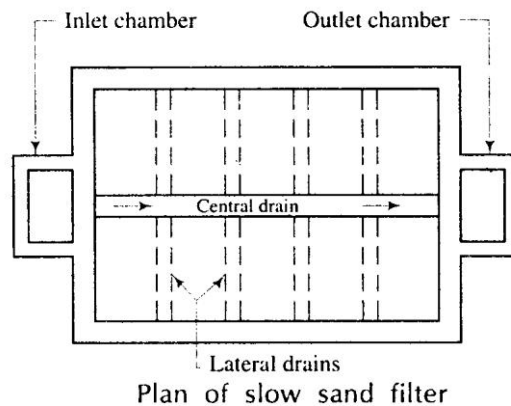

Fig.6.4

(3) **BASE MATERIAL:** The base material is gravels & it is placed on the top of under drainage system .

Its depth varies from 300mm to 750mm .It is usually graded and laid in layers of 150mm .The topmost layer should be small size gravel and the lowest layer should be of bigger size gravel . Followings is a typical section of base material.

Top most layer 150mm depth –size 3mm to 6mm

150mm depth-size 6mm to 20mm

150mm depth –size 20mm to

150mm depth – size 40mm to 65mm

Total 600mm depth.

**(iv) FILTER MEDIA OF SAND:**

- ❖ A layer of sand placed above the gravels.
- ❖ The depth of sand layer varies from 600mm to 900mm.
- ❖ The effective size of sand varies from 0.20 mm to 0.30mm & the uniformity coefficient about 2 to 3.
- ❖ The finer the sand, the better will be the efficiency of filter regarding the removal of bacteria but in that case, the output from the filter is lowered.

**(v) APPURTENANCE:**

- ❖ The various appurtenances are to be installed for the efficient working of slow sand filter.
- ❖ The devices for measuring loss of head for controlling depth of water above sand layer. And for measuring rate of flows through filter are to be suitably installed.
- ❖ The vertical air pipe passing through layer of sand help in proper function of filtering layer.

**(7) WORKING & CLEANING :**

- ❖ The water allowed to enter the filter through the inlet chamber. It descends through the filter media and during this process it gets purified.
- ❖ Water is then collected in the outlet chamber and taken to the clear water storage tank.
- ❖ The depth of water filter is to be carefully decided. It should neither be too small nor too high. Generally it is kept as equal to the height of filter media of sand.
- ❖ For the purpose of cleaning the top layer of sand is scrapped or removed through a depth of about 15mm to 25mm. The water is then admitted to the filter. But the purified water is not taken into use until the formation film around sand grain occurs.

**(8) RATE OF FILTRATION:** - The rate of filtration of a normal slow sand filter varies from 100 to 200 liters/ hours/  $m^2$  of filter area.

**RAPID SAND FILTERS ( GRAVITY TYPE): -**

- 1) **Purpose:** - The great disadvantages of a slow sand filter are that it requires considerable space for its installation. This requirement makes it uneconomical for places where land values are high.

The difficulty of requiring moves space for slow sand filters can be obviated by increasing the rate of filtration which is accomplished in rapid sand filter by increasing the size of sand.

- 2) **Essential parts:** - Fig shows the layout of a typical rapid sand filter (gravity type ) . It consists of the following five parts.

- i) Enclosure tank
- ii) Under drainage system
- iii) Base material
- iv) Filter media
- v) Appurtenances

- i) Enclosure Tank: A watertight tank is constructed either of masonry or concrete.

- ❖ The side and floor are also coated with waterproof material.
- ❖ The depth of tank is about 2.5m to 3.5m.
- ❖ \*The surface area of a exit of rapid sand filter varies from 10m<sup>2</sup> to 30m<sup>2</sup>.

- ii) Under drainage system: There are various forms of under drainage system of a rapid sand filter and most of them are patented by the manufacturers.

\*Following are two common types of under drainage system

- a. perforated pipe system
- b. pipe and strainer system

- a) **Perforated pipe system:** In this system there is a central drain or manifold and to this manifold the various lateral drains are attached as shown in fig. 6.5

- ❖ The drains are usually made of cast-iron.
- ❖ The lateral drains are placed at a distance of about 150mm to 300mm.
- ❖ The lateral drains are provided with holes at the bottom side and such holes make an angle of 20° with the vertical as shown in fig. 6.5
- ❖ The perforated pipe system is economical and simple in operation.

b) **Pipe and strainer system:** In this system also there is a central drain or manifold with lateral drains attached on either side as shown in the fig. But in this system the strainers are placed on lateral drains instead of drilling holes.

- ❖ A strainer is a small pipe of brass. It is closed at top and contains holes on its surface as shown in fig.6.5
- ❖ The strainers are either screwed or fixed on the top of lateral drains.
- ❖ When pipe and strainer system is adopted the compressed air is used for the purpose of washing the filter. This results in saving of wash water.

Following general rules should be observed in designing the under drainage system: -

- I. The ratio of length of lateral drain to its diameter should not exceed 20.
- II. The cross sectional area of central drain should be about twice the cross sectional area of lateral drain.
- III. The total cross sectional area of perforations should be about 0.20% of the total filter area.
- IV. The cross sectional area of lateral should be about two to four times the total cross sectional area of perforations in it.
- V. The perforations in the lateral drain should be of diameter 6mm to 12mm.
- VI. The spacing of perforation in the lateral drain should vary from 75mm to 200mm center to center.

**(iii)BASE MATERAIL:** The base material is gravel and it is faced on the top .of under drainage system.

- ❖ \*The gravel to be used for best material should be clean and free from clay , dust, silt and vegetable matter.

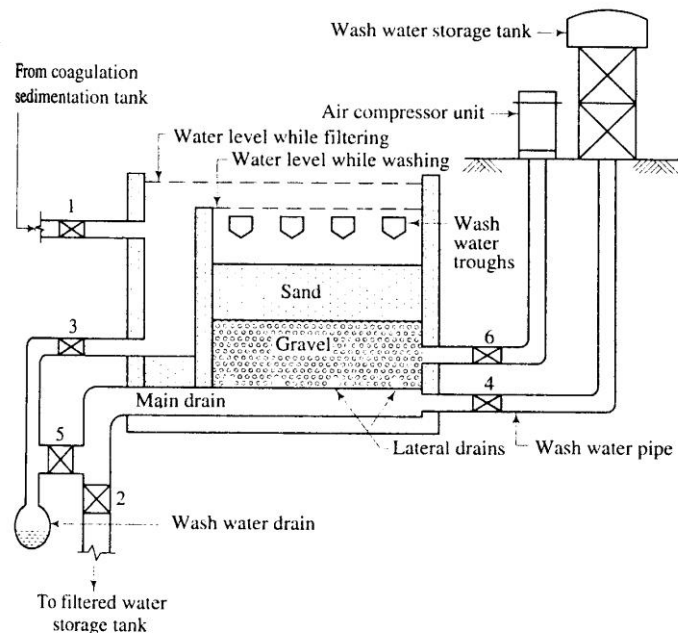

Layout of a typical rapid sand filter (gravity type)

**Fig.6.5**



Valve 3 – Waste water Valve to drain water from inlet chamber.

Valve 4 – Wash water storage tank Valve

Valve 5 – Waste water Valve to drain water from main drain.

Valve 6 – Compressed air Valve

- ❖ The Valve 1 is opened and the water from coagulated sedimentation tank is allowed to enter the filter.
  - ❖ The Valve 2 is opened to carry filtered water to the filter water storage tank. All other Valves are kept in closed position. Thus when filter is in working condition only Valves 1 and 2 are in open position.
  - ❖ When the filter requires cleaning or washing it is carried out follows.
    - I. The Valves 1 and 2 are closed.
    - II. The Valves 4 and 6 are opened out. The wash water is then forced in the upward direction through the under drainage system, base material and filter media of sand. The compressed air assists the cleaning process of filters.
    - III. The Valve 6 is closed and the Valve 3 is opened out to carry dirty water through the inlet chamber to the wash water drain.
    - IV. When washing of filter is over, the Valves 3 and 4 closed and Valve 1 and 5 are opened out. Thus, when filter is put into use after washing, the filtered water in the beginning is led to the wash water drain through main drain. This is continued for few minutes to condition the filter.
    - V. The Valve 5 is closed and the valve 2 is opened out to put the filter in the normal working condition.
- 4) **Loss of head and negative head:** -When water passes through the filter it has to resist the frictional resistance. It therefore losses some of its head. The loss of head can easily be computed by knowing the water level in the filter and pressure of water in the outlet pipe. The difference between the two head s indicates the loss of head in filter. In the beginning when the filter is cleaned the loss of head is very small about 150mm. `to 300mm. the loss of head then gradually goes on increasing. The loss of head can be measured by inserting piezometers in filter as shown in fig. The difference of water level in two tubes indicates the loss of head.
- A stage then comes when frictional resistance offered by filter media exceeds the static head above sand bed. This is developed due to the deposit of suspended matter

in top layer of about 100mm to 150mm. thickness. The lower portion then act more or less like a vacuum and the water is succeed through the filter media rather than flittered through it. The fall of liquid level in the piezometer tube below the center line of under drainage system indicates the negative head.

- The negative head thus formed tense to release dissolved air and other gasses present in water. The bubbles stick to the sand grains and the working of filter is seriously disturbed. This phenomenon is known as air binding as air binds filter and stops its working. The rate of filtration is consequently greatly reduced.
  - In case of rapid sand filter the allowable loss of head is about 3m. To 3.5m. and the allowable negative head is about 1200mm. The filter is to be washed when this limit of the allowable loss of head has been reached it is usually cleaned after 2 to 3 days.
- 5) **Troubles in operation:** - Following two troubles are generally encountered in operating rapid sand filter.
- I. **Mud balls:** - The mud ball are generally formed near the top of filter media. They may even be formed and distributed throughout the filter. The mud balls are formed or caused due to insufficient washing of sand grains. The gelatinous film formed during filtration is not separated out from sand grains during washing. The mud balls interfere with the normal working of the filter and their size is about 25mm to 50mm.
  - II. **Cracking of filters:** - the fine material contained in the top layer of filter shrinks and this shrinkage leads to form cracks in the filter. These cracks are prominent near wall junctions.  
To remove these troubles, the following remedies are adopted.
    - i. The mud balls are broken with the help of rakes or some such equipment.
    - ii. The working of filters is carried out with high velocity of water.
    - iii. The damaged portion of filter media is replaced.
- 6) **Rate of filtration:** - The chief advantage of a rapid sand filter is that its rate of filtration is very high. It is about 3000 to 6000 liters/ hour/  $cm^2$  the high rate of filtration results in considerable saving of space for the installation of filter.
- 7) **Efficiency of rapid sand filter:** -The efficiency of rapid sand filter is as follows.



- i. Bacterial load: - The rapid sand filters are less effective in the removal of bacterial load. It is expected that they remove about 80 to 90 percent of bacterial impurity present in water.
- ii. The rapid sand filters are highly efficient in colour removal and the intensity of colour can be brought down below 10 on cobalt scale.
- iii. Turbidity: - The rapid sand filter can remove turbidity to the extent of 35 to 45 p.p.m. As water entering rapid sand filter is invariably given the treatment in coagulation sedimentation tank, it possesses less turbidity. This turbidity is brought down easily to the permissible limits by rapid sand filters.

**PRESSURE FILTERS:** -These filters are more or less similar to the rapid sand filters ( gravity type) except with the following differences.

- 1) **Meaning of the term – pressure filter:** - The pressure filter does not indicate that the water is pumped through the filter under a high pressure loss. But it indicates that a filter is enclosed in space and the water passes under pressure greater than atmospheric pressure. This pressure can be developed by pumping and it may vary from 0.3 to 0.7  $N/mm^2$ .
- 2) **Construction:** - The pressure filters are closed cylinders either riveted or welded. They may be of horizontal or vertical type. The diameters of pressure filters vary from 1.50m to 3.00m. and their lengths or height varies from 3.50m. to 8.00m. the manholes are provided at top for inspection.

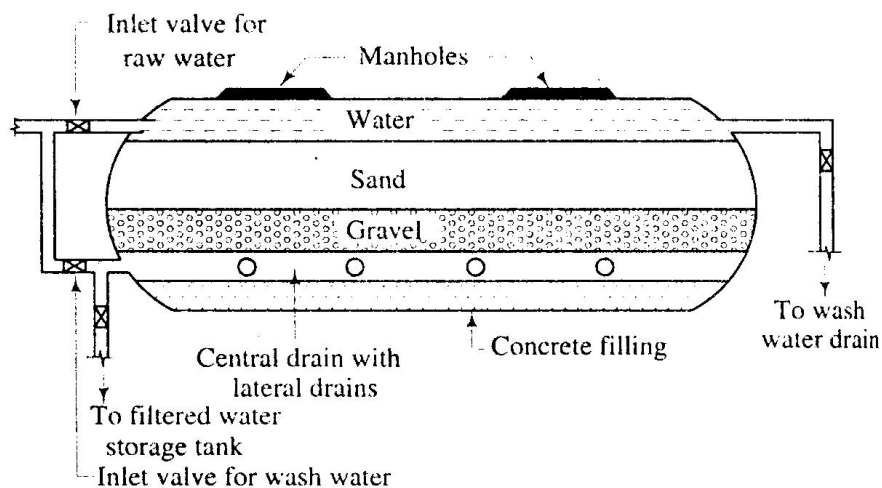

Pressure filter — horizontal type

**Fig.6.6**

- 3) **Working:** - The water mixed with coagulant is directly admitted to the pressure filter. Thus the flocculation takes place inside the pressure filter itself. In normal working condition, all valves are closed except those for raw water and filtered water. The water is admitted through inlet and after it is filtered, it is collected in the central drain and converged to the filtered water storage tank.
- 4) **Cleaning:** - The compressed air may be used to agitate sand grains,
  - ❖ The valves for raw water and filtered water are in closed position and those for wash water and wash water drain are in open position during the operation of washing of filter.
  - ❖ The cleaning of pressure filters may be required more be frequently.
  - ❖ The automatic pressure filters are available in which washing of filter is done automatically at a predetermined interval of time or loss of head.
- 5) **Rate of filtration:-** The rate of filtration of pressure filters is high as compare to that of rapid sand filters. It is about 6000 to 15000 liters/hour/ $m^2$ . Of filter area as compared to that of 3000 to 6000 liters/hour/ $m^2$ . Of rapid sand filters.
- 6) **Efficiency:** - The pressure filters are found to be less efficient than the rapid sand filters in terms of bacterial loads, colour and turbidity.
- 7) **Suitability:** - The pressure filters are more suitable for public water supply projects. But they can be installed for small water supply projects such as colonies of few houses, industrial plants, private estates, swimming pools etc.

## CHAPTER-7

### DISTRIBUTION SYSTEM

#### GENERAL

After complete treatment of water, it becomes necessary to distribute it to a number of houses, estates, industries and public places by means of a network of distribution system. The distribution system consists of pipes of various sizes, valves, meters, pumps, distribution reservoirs, hydrants, stand posts etc. The pipe lines carry the water to each and every street, road. Valves control the flow of water through the pipes. Meters are provided to measure the quantity of water consumed by individual as well as by the town. Hydrants are provided to connect the water to the fire fighting equipments during fire. Service connections are done to connect the individual building with the water line passing through the streets. Pumps are provided to pump the water to the elevated service reservoirs or directly in the water mains to obtain the required pressure in the pipe lines.

The following are the requirements of a good distribution system:

- (i) It should convey the treated water up to the consumers with the same degree of purity.
- (ii) The water should reach to every consumer with the required pressure head.
- (iii) Sufficient quantity of treated water should reach for the domestic and industrial use.
- (iv) The distribution system should be economical and easy to maintain and operate.
- (v) It should be able to transport sufficient quantity of water during emergency such as fire-fighting.
- (vi) It should be reliable so that even during breakdown or repairs of one line water should reach that locality from other line.
- (vii) During repair work, it should not cause obstruction to the traffic.
- (viii) It should be safe against any future pollution. The pipe lines as far as possible should not be laid below the sewer lines.
- (ix) The quantity of the pipes laid should be good and it should not burst.
- (x) It should be water-tight and the water losses due to leakage should be minimum as far as possible,

## METHOD OF DISTRIBUTION

Depending upon the topography of the country, any one of the following three methods may be adopted for the distribution of water.

1. **Gravity system:** - In this system the water is conveyed through pipes by gravity only. The gravity system is the most reliable methods of distribution. But it is useful only when the source of water supply is situated at a higher level than that of distribution area. Fig.7.1 shows the gravity system with hydraulic gradients during maximum and minimum demands. In case of a fire, the motor pumps may be used to develop high pressure for fire fighting purpose.

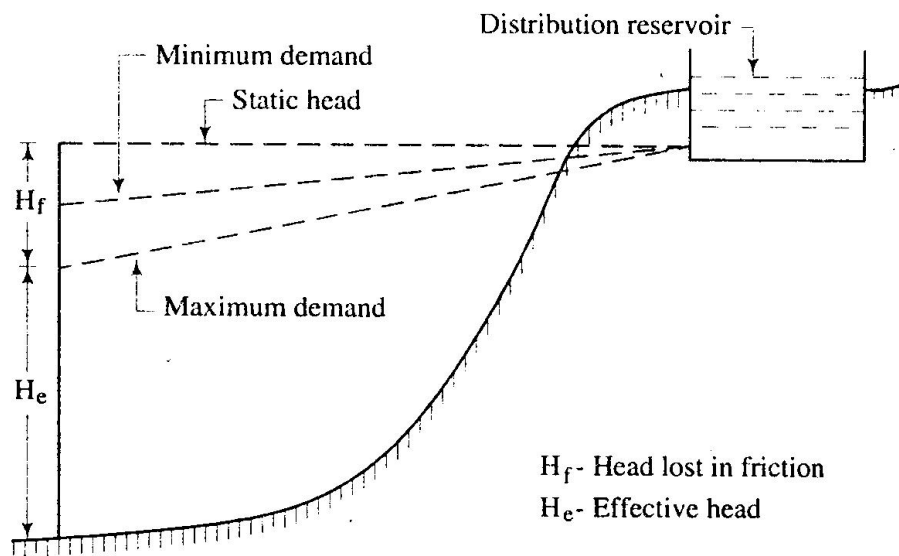

Gravity system

Fig.7.1

2. **Gravity and pumping system combined:** -In this system, the treated water is pumped and stored in an elevated distribution reservoir. The excess water during low consumption remains in the elevated reservoir and it is supplied during the peak period. The pumps are generally worked at constant rate and this rate of pumping is so adjusted that the excess quantity of water stored in reservoir during low consumption is nearly equal to the extra demand of water during peak period. Fig.7.2 shows the combined gravity and pumping system with hydraulic gradients during maximum and minimum demand.

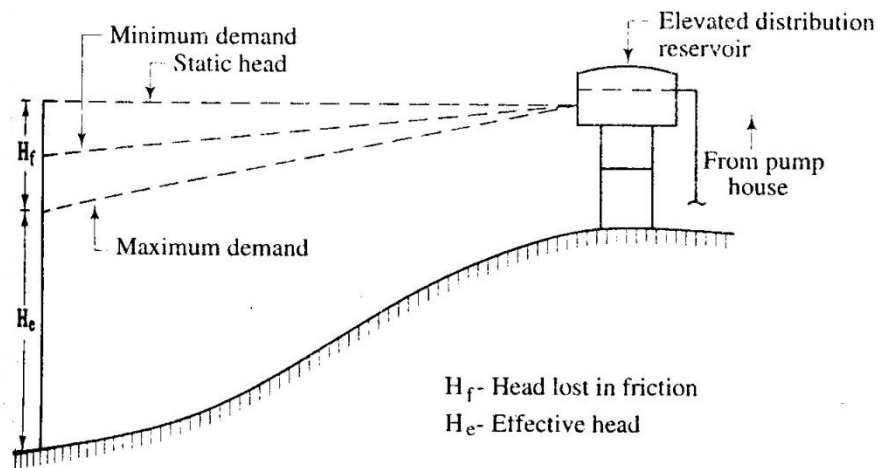

Combined gravity and pumping systems

**Fig.7.2**

This method of distribution is usually applicable in most of the cases and it has the following advantages:

- I. In case of a fire, the motor pumps can be used to develop high pressure or a fire demand can directly be satisfied from pump house after closing the inlet valve for elevated reservoir.
  - II. In this method the pumps are generally worked at uniform rate. Hence, they suffer less wear and tear.
3. **Pumping system:** - In this system, the water is directly pumped into the mains leading to the consumers. The number of pumps required in this system will depend on the demand of water. Fig. Shows the pumping system with hydraulic gradients during maximum and minimum demands.

**SYSTEMS OF SUPPLY OF WATER:** - Following are the two systems of supply of water which are based on the duration of supply.

- 1) **Continuous system:** - In this system of supply, the water is supplied to the consumers for 24 hours of day. This is the most ideal system of supply and it should be adopted as far as possible.

The only disadvantage of this system is that considerable wastage of water occurs, if consumers do not possess civic sense regarding the importance of treated water. One recommended way to avoid this defect of this system is to supply water through meters. Whether it is desirable to install meters or not is a

debatable question and hence, the decision to install meters should be taken after careful considerations and deliberations.

- 2) **Intermittent system:** - In this system of supply the water is supplied during certain fixed hours of day only. The usual period is about one to four hours in the morning and about same period in the afternoon. For instance, the water may be supplied from 6.30 a.m. to 10.30 p.m. and from 5.30 p.m. to 8.30 p.m. The timing of supply of water may be changed to suit the seasons of year and it is more or less a matter of convenience only. This system of supply of water proves to be useful for the following two conditions:
- I. The available pressure is poor and
  - II. The quantity of water available is not sufficient to meet with various demands for water.

**Methods of layout of distribution of pipes:-** Following are the four main methods of laying distribution pipes:

- 1) Dead end method
- 2) Grid iron method
- 3) Circular method
- 4) Radial method

- 1) **Dead-end method:** - This is also known as the free system of layout and it consists of one supply main from which sub-mains are taken. The sub-mains again divided into several branch lines from which service connections are given to the consumers.

**Advantages:** - Followings are the advantages of the dead-end method:

- I. It is possible to workout accurately the discharge and pressure at any point in the distribution system. The design calculations are simple and easy.
- II. The cut-off valves required in this system of layout are comparatively less in number.

**Disadvantage:** - Following is the disadvantage of dead-end method:

- I. During repairs the large portion of distribution area is affected. It results into great inconvenience to the consumers of that area.
- 2) **Grid-iron method:** - This is also known as the interlaced system or reticulation system. The mains, sub-mains and branches are interconnected with each other as shown in fig.7.3

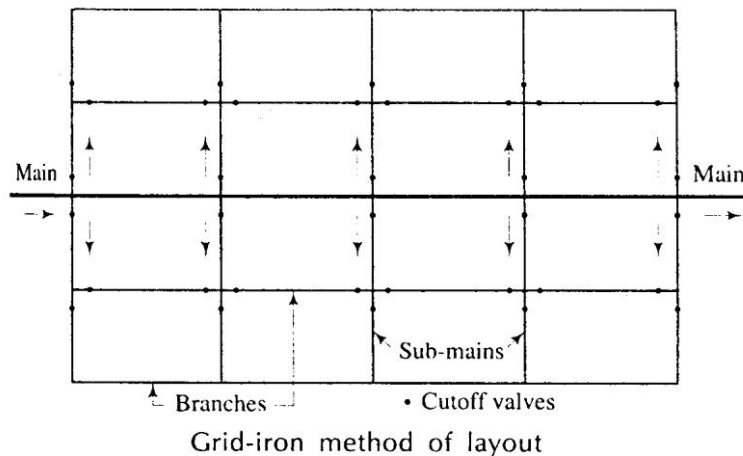

**Fig.7.3**

**Advantages:** - Followings are the advantages of grid-iron method:

- i. In case of repairs a very small portion of the distribution area will be affected.
- ii. There is free circulation of water and hence, it is not liable for pollution due to stagnation.

**Disadvantages:** - Followings are the disadvantages of grid-iron method:

- i. The cost of laying water pipe is more.
  - ii. The grid- iron system of layout requires longer lengths of pipes.
- 3) **Circular method:** - This is also known as the ring system and a ring of mains is formed around the distribution area as shown in fig.7.4. This system possesses advantages and disadvantages as those of grid-iron system.

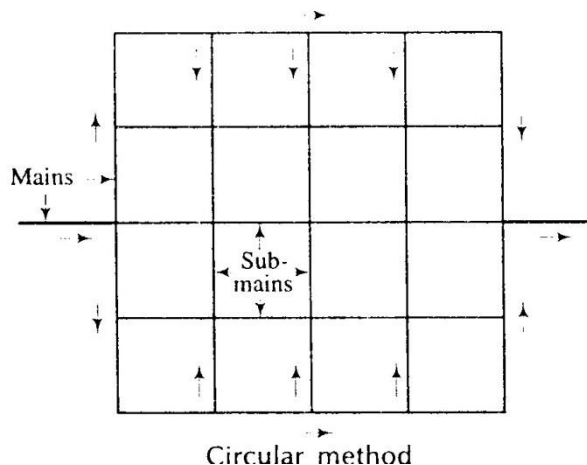

**Fig.7.4**

- 4) **Radial method:** - This method of layout is just the reverse of the ring method. In this system, the water is taken from the mains and pumped into the distribution reservoirs which are situated at centres of different zones as shown in fig.7.5. The water is then

supplied through radially laid pipes. The radial method of layout gives quick service and the calculations for design of sizes of pipes are simple. The radial method is most suitable for towns having roads laid out radially.

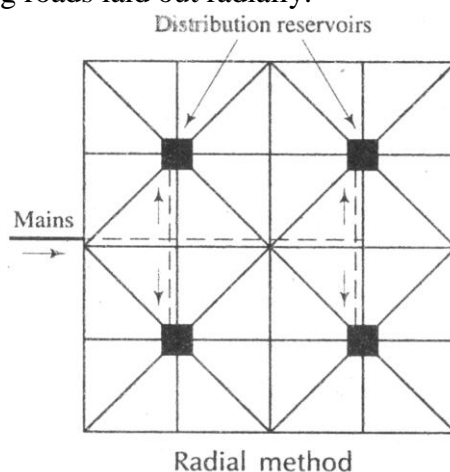

**Fig.7.5**

### **PRESSURE IN THE DISTRIBUTION SYSTEM**

When the water enters in the distribution main, the water head continuously is lost due to friction in pipes, at entrance of reducers, due to valves, bends, meters etc. till it reaches the consumer's tap. The net available head at the consumer's tap is the head at the entrance of the water main minus all the losses in the way. The effective head available at the service connection to a building is very important, because the height up to which the water can rise in the building will depend on this available head only. The greater the head the more will be the height up to which it will rise. If adequate head is not available at the connection to the building, the water will not reach the upper storeys (i.e., 2nd, 3rd, 4th etc.). To overcome this difficulty the required effective head is maintained in the street pipe lines. The water should reach each and every consumer therefore it should reach on the uppermost storey. The pressure which is required to be maintained in the distribution system depends upon the following factors:

- (i) The height of highest building up to which water should reach without boosting.
- (ii) The distance to the locality from the distribution reservoir.
- (iii) The supply is to be metered or not. Higher pressure will be required to compensate for the high loss of head in meters.
- (iv) The supply is to be metered or not. Higher pressure will be required to compensate for the high loss of head in meters.
- (v) The funds available for the project work.



## CHAPTER-8

### APPURTENANCE IN DISTRIBUTION SYSTEM

#### Introduction:-

These days water treatment is essential for the safe and sound supply of water to manage the local requirements. When a mass of water is completely treated that after its needs to be distributed among the number of houses, Estates, industries and public places in a very planned way means this network is known as distribution system. This system is mainly enhanced by pipes of different sizes, valves, meters, pumps distribution reservoir, hydrant stand posts etc.

This system should provide the treated water with some degree of purity and should maintain required pressure head then it should be economical and reliable use. For efficient distribution it is required that water should reach or convey to every consumer with required rate of flow. So some pressure in the pipe is required which should force the water to convey at every demand. So considering the rate of flow pressure head in order to maintain a sound distribution system this system is classified as follows:-

- Gravity System.
- Pumping System.
- Combined Gravity System & Pumping System

#### Some Important fitting Items.

In a network of distribution system a number of items are required but mainly Valves, Fire hydrants, and water meter plays a vital role in the distribution system and they are described as follows.

Valves:-Generally valves are needed to control the flow of water to regulate pressure to release or admit air to prevent flow of water in opposite direction. Valves are fitted according to the purpose of distribution. Some different types of valves are given below.

- a. Sluice valves
- b. Check Valves
- c. Air valves.

**a. Sluice valves:-**

These are also known as gate valves and are mostly used in water work. This is cheap and offer less resistance to flow of water. Gate valves control the flow of water through pipes and fixed in the main lines bringing water from the source to a town at 3 to 5 km interval.

As shown in fig.8.1

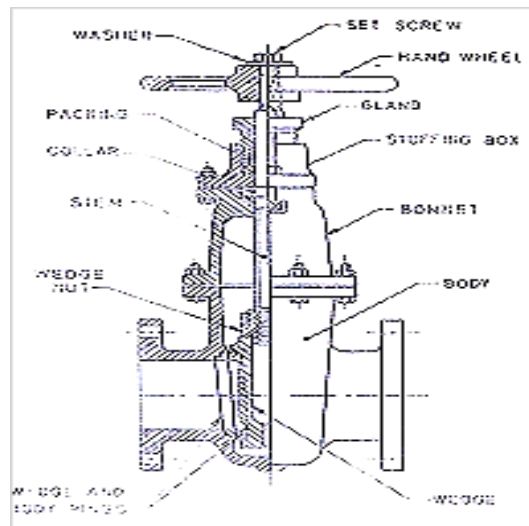

Fig.8.1

**b. Check Valves:-**

This is also known as return or non return valves. It automatically allows water to flow only in one direction and prevent it flowing in reverse direction. This type of valves has typical rises in one directional flow of water.

As shown in fig.8.2

Fig.8.2

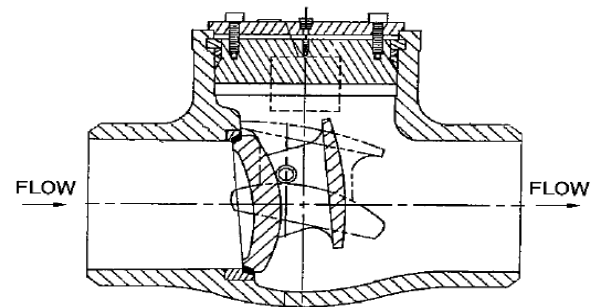

**c. Air Valves:-**

When water enters in pipe line some it also carries some air with it which tends to accumulate at high point of the pipe. When the quantity of air increases it causes seivour blockage to the flow of water therefore it is most essential to remove the accumulated air from the pipe line. Air valves are used for this purpose. As shown in fig.8.3

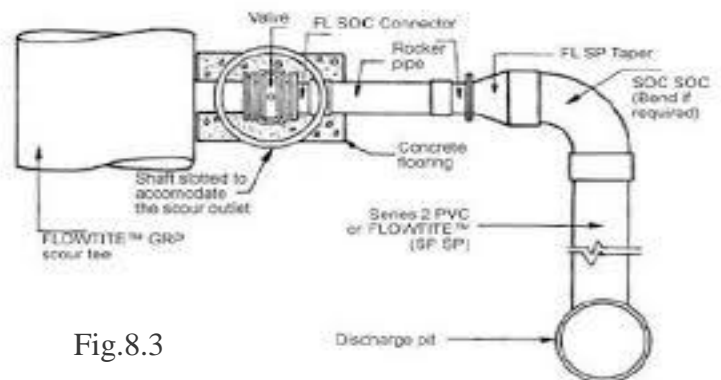

Fig.8.3

### Fire Hydrants:-

This device are used for tapping water from mains for fire extinguisher, Street washing flushing swear line etc.. This are generally provided at all junction of road and at 100-130mt apart along road.

The hydrants are of two types.

Flush hydrants:- This type of hydrants are installed in an underground bricks chamber flush with the footpath. It is covered from top by a C.I. cover. Some distinct sign is provided at it in order to locate the position of hydrant even at night. As shown in fig 8.4



Fig.8.4

**Post hydrant:-** This type of hydrants barrel is projected about 60-90cm above the ground surface. These hydrant have a long stem with screw and nut at the top to regulate the flow of water. The post hydrant is connected to the main pipes through a branch pipes and it is operated by means of a gate valve. as shown in fig 8.5



Fig 8.5

### Water meters:-

This types of device are used to determine the quantity of water flowing through pipes. This are usually installed to measure the water amount supplied to provide house , industries public building etc. as shown in fig 8.6 Water meters are of two types:-

The positive displacement type

The velocity of inferential types.

**Uses:-** For the typical use of water meter the wastage of water is reduced.

It mostly used for private building, industries and other public sector.

It may be adopted by fire brigade.

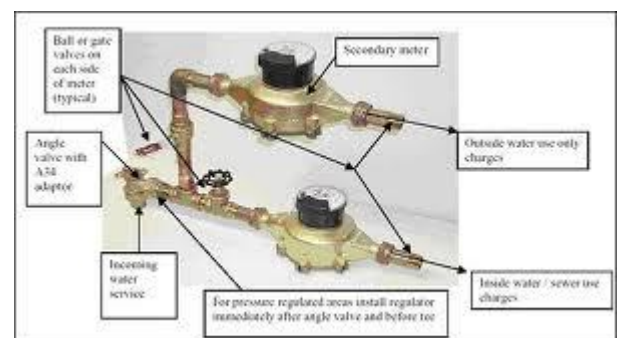

fig 8.6

## CHAPTER-9

### W/S PLUMBING IN BUILDING

#### **Method of water connection from water mains to building supply**

The water receiving tank method, in which water is supplied via a water receiving tank, is generally used in apartment buildings and other high-rise structures, but there is also an approach known as the direct-connect method, in which water is supplied directly to faucets in the building without using a water receiving tank. This direct-connect method includes the direct-connect/direct-pressure method, in which water is supplied directly using only the water pressure in the water main, and the direct-connect/boost method, in which a boost pump is installed on the water pipe to bring the water pressure in the water main up to a sufficient level.

#### **General layout of plumbing arrangement for water supply in multi-storied building**

For plumbing purposes, the term “multi-storey” is applied to buildings that are too tall to be supplied throughout by the normal pressure in the public water mains. These buildings have particular needs in the design of their sanitary drainage and venting systems. Water main supply pressures of 8–12 metres (25–40 feet) can supply a typical two-storey building, but higher buildings may need pressure booster systems. In hilly areas, the drinking-water supply pressures will vary depending on the ground elevation. In these cases, the water authority may have to specify areas where particular supply pressures can be relied upon for the design and operation of buildings. Where a building of three or more storey’s is proposed a certificate should be obtained from the drinking-water supply authority guaranteeing that the present and future public drinking-water supply pressure will be adequate to serve the building. If the public water pressure is inadequate, suitable means shall be provided within the building to boost the water pressure.

#### **Water supply fittings-features, uses, purpose, fixing and jointing:-**

#### **PIPES AND PIPE FITTINGS**

Various types of materials which are used in the construction of sewer pipes have been described in chapter 5. All those materials are also used in the construction of pipes required in house drainage. In house drainage works stoneware, asbestos cement, lead and iron pipes are used

For jointing, laying and fixing of soil waste, rain water and vent pipes of various types of fitting are required. as shown in fig 9.1

**FIXING AND JOINTING, PIPES AND ACCESSORIES**

Rain water, soil waste and vent pipes can be embedded in the walls and floors or fixed on them. When they are embedded no fixing devices are required. But for ease in repairs and maintenance usually they are fixed on the outside of walls. For fixing those special types of brackets are required. fig shows one most common type of fixing bracket having aluminium painted clips. These brackets fit closely round the pipe or accessory directly beneath the socket and have ears for securing to the face of the structure. When fixed, they present a neat appearance.

The jointing of pipes and accessories is done as follows. First a gasket or hemp yarn saturated with Bitumastic jointing compound is caulked to about 2.5cm depth. Then the space between the collar and plain end is ground with stiff mortar of cement. Fig shows the method of jointing A.C. pipe

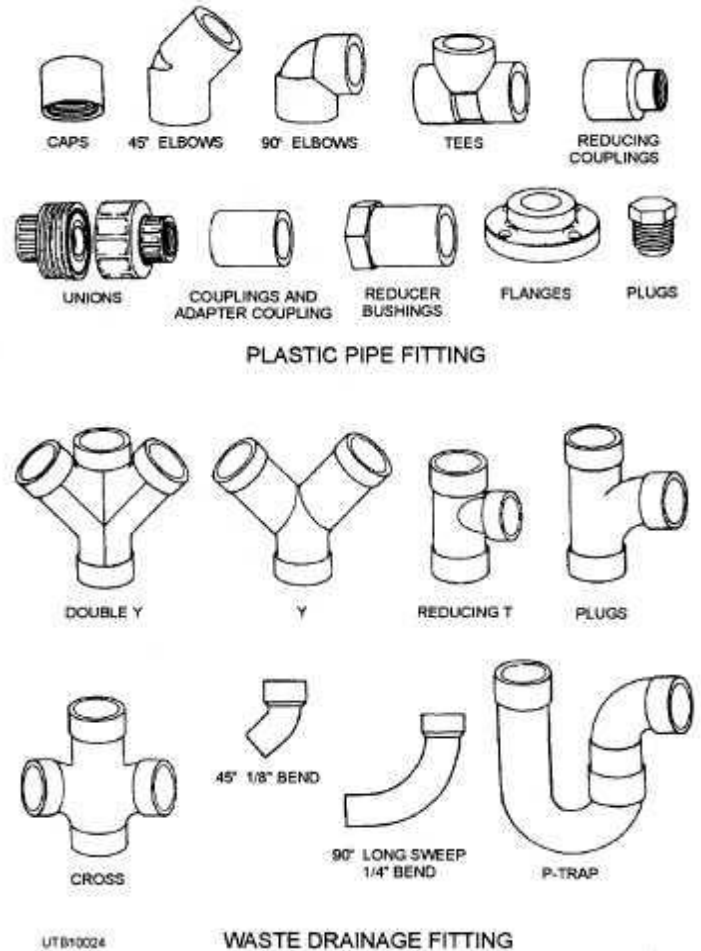
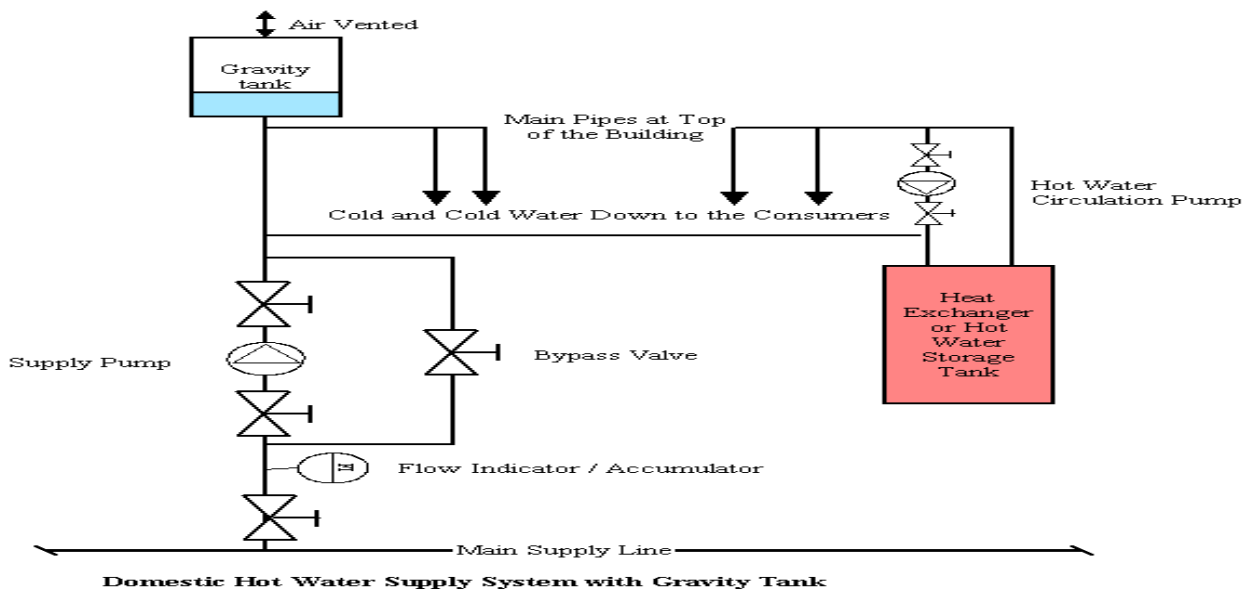

Fig 9.1



After fixing and jointing all pipes and accessories must be tested for water tightness. This is done by dividing the whole work in section and testing each section one by one.

### HOT WATER SUPPLY:-

The water provided by hot water supplies in residential and public buildings and in industrial enterprises for their operational and daily needs must be potable and must satisfy the requirements of the All-

Union State Standards. The quality of water intended for technical use is determined by the type of production service it will fulfill. Hot water supplies may be either centralized or local (decentralized). In centralized systems, the heat is generated by heat and electric power plants; and the so-called waste heat of industrial enterprises, underground sources, and other sources is also used. The heat is transmitted to consumers through heating system pipelines. The treatment of hot water is carried out at the heat sources themselves and at central heating points or right in the home. In local systems, the source of heat for warming the water is located at the place where the water is used. A centralized hot water supply may be a closed system in which the water is warmed by a heat-transfer medium (water or steam) from heating networks in water heaters that have been installed at central heating points or directly within the home. In hot water supplies built as open systems, the consumer obtains hot water directly from a heating network. This does away with the need to install water heaters in homes or at centralized heating points and lessens the possibility of corrosion in local pipelines. However, the maintenance of a demand level in such systems requires large volumes of water that have undergone preliminary treatment to prevent scaling and corrosion in the pipelines and the heat-

transfer equipment. The maximum water temperature in hot water supplies is 75° C and the minimum (at water faucets) is 60° C.

To prevent cooling of the water in hot water supply delivery pipelines, a constant circulation is maintained during low-demand periods with the help of so-called circulation pipelines. In baths and showers there are heaters connected to the circulating system; with these the rooms are warmed and the towels are dried.

In order to even out the high- and low-demand loads and to cut the costs of heat sources, heat exchangers, heating networks, and water treatment, hot water accumulator tanks are used in centralized systems to store the hot water during low-demand periods, for its distribution during high-demand periods. All new residences and public buildings being constructed in the cities and industrial settlements of the USSR, as a rule, are provided with centralized hot water supplies. This also applies to all industrial enterprises.

In a local hot water supply system, the water heaters are installed right at the locations where the hot water will be used (baths, showers, washing machines, production equipment) and are heated by the burning of fuel (gaseous, liquid, or solid) or electric power. These devices usually require considerable expenditures of time and labor for servicing and, as a rule, do not operate continuously.

### **Electric water supply:-**

The use of electricity for public and private supply of water and for wastewater treatment is an important factor in economic growth and sustainability in the United States. As the economy grows, all sectors increase their demand for fresh water and generate additional quantities of waste water that must be treated before discharge. This report estimates unit electricity requirements for the supply of fresh water and the treatment of wastewater across the U.S. economy. These unit electricity requirements are then used to project total electricity requirements for selected sectors of the economy. Sectors included in this analysis include:

- Public water supply agencies
- Publicly owned wastewater treatment facilities and privately operated wastewater treatment facilities
- Self-supply of water to the domestic, commercial, industrial, mining, irrigation, livestock, and thermal power generation sectors

The main question addressed by the study is: “Will there be sufficient electricity available to satisfy the country’s need for fresh water.” In order to make this assessment, unit electricity requirements for water supply and wastewater treatment were estimated. These were used in conjunction with projections of water consumption requirements for various economic sectors to develop aggregate electricity requirements for the period 2000 through 2020, with an extrapolation to the year 2050. Where possible, projections were carried out for each of the nine geographical areas defined by the U.S. Census Bureau.

The projections of electricity requirements for water delivery and wastewater treatment were also compared to a national forecast of electricity consumption by sector through the year 2020 to determine whether the estimates were reasonable. Further, issues and caveats regarding the forecast estimates were identified, and to the extent possible their impact on the estimates was qualified and quantified..

**Solar water system:**

We are blessed with Solar Energy in abundance at no cost. The solar radiation incident on the surface of the earth can be conveniently utilized for the benefit of human society. One of the popular devices that harness the solar energy is solar hot water system (SHWS).

A solar water heater consists of a collector to collect solar energy and an insulated storage tank to store hot water. The solar energy incident on the absorber panel coated with selected coating transfers the heat to the riser pipes underneath the absorber panel. The water passing through the risers get heated up and are delivered to the storage tank. The re-circulation of the same water through absorber panel in the collector raises the temperature to 80 C (Maximum) in a good sunny day. The total system with solar collector, storage tank and pipelines is called solar hot water system.

Broadly, the solar water heating systems are of two categories. They are : closed loop system and open loop system. In the first one, heat exchangers are installed to protect the system from hard water obtained from bore wells or from freezing temperatures in the cold regions. In the other type, either thermosyphon or forced circulation system, the water in the system is open to the atmosphere at one point or other. The thermosyphon systems are simple and relatively inexpensive. They are suitable for domestic and small institutional systems, provided the water is treated and potable in quality. The forced circulation systems employ electrical pumps to circulate the water through collectors and storage tanks. The choice of system depends on heat requirement, weather conditions, heat transfer fluid quality, space



availability, annual solar radiation, etc. The SHW systems are economical, pollution free and easy for operation in warm countries like ours. Based on the collector system, solar water heaters can be of two types. Flat Plate Collectors (FPC) based Solar Water Heaters The solar radiation is absorbed by Flat Plate Collectors which consist of an insulated outer metallic box covered on the top with glass sheet. Inside there are blackened metallic absorber (selectively coated) sheets with built in channels or riser tubes to carry water. The absorber absorbs the solar radiation and transfers the heat to the flowing water. There are 60 BIS approved manufacturers of Solar Flat Plate Collectors. Evacuated Tube Collectors (ETC) based Solar Water Heaters Evacuated Tube Collector is made of double layer borosilicate glass tubes evacuated for providing insulation. The outer wall of the inner tube is coated with selective absorbing material. This helps absorption of solar radiation and transfers the heat to the water which flows through the inner tube. There are 44 MNRE approved ETC based solar water heating suppliers. Solar water heating is now a mature technology. Wide spread utilization of solar

## CHAPTER-10

# SANITARY ENGINEERING

### **Introduction :**

Sanitation is a term which reseed to indicate the proper arrangement for the collection, treatment and disposal of air the waste water produced from different sources like bathroom, kitchen, lavatory, street wash etc and the science or technique that stands behind the sanitation is known as sanitary engineering. Proper sanitation is the most essential at every town or city even at every individual for a sound and safe community.

### 1- **Aims and Objectives :**

- The following are the basic aims and object of sanitary engineering.
- For the proper collection and disposal of wastes at every individuals house, public sector etc.
- To prevent the accumulation of disposed water.
- It also makes the final disposal at land or nearly water source after some primary treatment.

### 2- **Definition and terms related to sanitary engineering :**

#### **Anti-siphon age pipe:**

A pipe which is installed in the house drainage to preserve the water seal of traps is known as anti-siphon age pipe. It maintains the metallization and does not allow the siphonic action.

#### **Siphon age:**

Water seal of traps may break due to siphonic action and it is known as siphon age. It takes place when water is suddenly discharged from a filterer on ripper flower.

#### **Vent Pipe:**

The pipe which is reseed for the purpose of ventilation is known as vent pipe.

#### **Refuse:**

It is reseed to indicate what is left as worthless and for the study of sanitary engineering and it is divided in 5 categories.

- **Garbage :**

The dry refuse means decayed fruits, grass, leaves, paper pieces etc.

- **Sewage :**

It is the whole liquid waste generated from latrines, urinals, stables etc.

It is the combination of sanitary sewage and storm water.

- **Fresh Sewage :**

The sewage which has been recently organized or produced.

- **Septic Sewage :**

The sewage which is undergoing the treatment process.

**Storm water:-** it is used to indicate the rain water of the locality.

**Sullage:-** it indicate the waste water from bathrooms , kitchens etc.

**Swear:-**the underground conduits of the drains trough which the sewage is conveyed.

**Sewerage:-** The entire science of collection and carrying sewage by water carriage system through sewers.

### **System of collection of sanitation:-**

For the disposal of waste water collection is the primary step and basically the sanitation of a town or city is done by following two methods. They are

- a. Conservancy system
- b. Water carriage system.

### **Conservancy System:-**

It is actually a out of date system but in some small town , village or underdeveloped area this system is still present. These systems are also called dry system. In this system various types of refuse and storm water are collected converged and disposed by different method so it is called **conservancy system**.

Garbage or dry refuse are collected in the dustbins placed along the roads and streets from where it is conveyed by trucks to the point of disposal. All the non combustible portion of the garbage are reused for filling of lower level areas to re claim the lands for future use. The combustible portions of the garbage are burnt and the decaying fruits leaves and vegetables are first dried and then disposed of by burning or in the manufacture of manure.

Similarly, human excreta or night soil is collected separately by human agency and also all the liquid and semi- liquid waste. After removal of night soil they are brought into trenches which are outside of the town and get buried,. After 2-3 years they became very good manure.

In **conservancy system** the silage and storm water are carried separately in closed or open drums up to the point of disposal where they are allowed to mix up with streams, rivers or sea without any treatment.

### **Water Carriage System:-**

With the development and advancement of cities urgent need was felt to replace the conservancy system with the some more improved type of system in which human agency should not be used for collection conveyance of sewage. After many experiments water is found as the cheapest substance for the collection and conveyance of sewage. As in the system water plays an important role. So it is called water carriage system. In this system all the refuse liquid and semi liquid waste are mix up with large amount of water and then they are taken out of the city with planned sewage system, where they can be disposed after necessary treatment in satisfactory manner.

### **Comparison between Conservancy System & Water Carriage System:**

<b>Sl.no.</b>	<b>Conservancy System</b>	<b>Water Carriage System</b>
<b>1.</b>	Initial cost is low	Initial cost is very high
<b>2</b>	Foul smell may found	There is no foul smell is occur
<b>3</b>	Excreta is not removed immediately	Excreta is removed immediately with water.
<b>4</b>	Storm water is carried in ritually surface drains hence no problem of pumping the storm water.	Sewage is treated before disposing off. It may or may not require pumping . It depends upon the topography of the town.
<b>5</b>	This system is fully dependent upon human agency	No human agency is require for this system.
<b>6.</b>	In this system the sewage is disposed without any treatment. So it may pollute the water course or disposed area.	In this system sewage is treated upto required degree of sanitation

## **CHAPTER-11**

### **QUANTITY OF SEWAGE**

#### **Introduction:**

- The sewage collected from the municipal area consists of wastewater generated from the residences, commercial centres, recreational activities, institutions and industrial wastewaters discharge into sewer network from the permissible industries located within the city limits.
- Before designing the sewer, it is necessary to know the discharge i.e., quantity of sewage, which will flow in it after completion of the project.
- Accurate estimation of sewage discharge is necessary for hydraulic design of the sewers.
- Far lower estimation than reality will soon lead to inadequate sewer size after commissioning of the scheme or the sewers may not remain adequate for the entire design period.
- Similarly, very high discharge estimated will lead to larger sewer size affecting economy of the sewerage scheme, and the lower discharge actually flowing in the sewer may not meet the criteria of the self cleansing velocity and hence leading to deposition in the sewers.
- Actual measurement of the discharge is not possible if the sewers do not exist; and where the capacity of the existing sewers is inadequate and need to be increased, still actual present discharge measurement may not be accurate due to unaccounted overflow and leakages that might be occurring in the existing system.
- Since sewers are design to serve for some more future years, engineering skills have to be used to accurately estimate the sewage discharge.

#### **Sources of sanitary sewage:**

- Water supplied by water authority for domestic usage, after desired use it is discharged in to sewers as sewage.

- Water supplied to the various industries for various industrial processes by local authority. Some quantity of this water after use in different industrial applications is discharged as wastewater.
- The water supplied to the various public places such as, schools, cinema theatres, hotels, hospitals, and commercial complexes. Part of this water after desired use joins the sewers as wastewater.
- Water drawn from wells by individuals to fulfil domestic demand. After uses this water is discharged in to sewers.
- The water drawn for various purposes by industries, from individual water sources such as, wells, tube wells, lake, river, etc. Fraction of this water is converted into wastewater in different industrial processes or used for public utilities within the industry generating wastewater. This is discharged in to sewers.
- Infiltration of groundwater into sewers through leaky joints.
- Entrance of rainwater in sewers during rainy season through faulty joints or cracks in sewers.

**Dry weather flow:**

- Dry weather flow is the flow that occurs in sewers in separate sewerage system or the flow that occurs during dry seasons in combined system.
- This flow indicates the flow of sanitary sewage. This depends upon the rate of water supply, type of area served, economic conditions of the people, weather conditions and infiltration of groundwater in the sewers, if sewers are laid below groundwater table.

**Evaluation of sewage discharge:**

- Correct estimation of sewage discharge is necessary; otherwise sewers may prove inadequate resulting in overflow or may prove too large in diameter, which may make the system uneconomical and hydraulically inefficient.
- Hence, before designing the sewerage system it is important to know the discharge / quantity of the sewage, which will flow in it after completion of the project and at the end of design period.

- Apart from *accounted water supplied* by water authority that will be converted to wastewater, following quantities are considered while estimating the sewage quantity:

**(1) Addition due to unaccounted private water supplies:**

People using water supply from private wells, tube wells, etc. contribute to the wastewater generation more than the water supplied by municipal authority. Similarly, certain industries utilize their own source of water. Part of this water, after desired uses, is converted into wastewater and ultimately discharged into sewers. This quantity can be estimated by actual field observations.

**(2) Addition due to Infiltration:**

This is additional quantity due to groundwater seepage in to sewers through faulty joints or cracks formed in the pipes. The quantity of the water depends upon the height of the water table above the sewer invert level. If water table is well below the sewer invert level, the infiltration can occur only after rain when water is moving down through soil. Quantity of the water entering in sewers depends upon the permeability of the ground soil and it is very difficult to estimate.

**(3) Subtraction due to water losses:**

The water loss, through leakage in water distribution system and house connections, does not reach consumers and hence, not appear as sewage.

**(4) Subtraction due to water not entering the sewerage system:**

Certain amount of water is used for such purposes, which may not generate sewage, e.g. boiler feed water, water sprinkled over the roads, streets, lawns, and gardens, water consumed in industrial product, water used in air coolers, etc.

**Net quantity of sewage:**

The net quantity of sewage production can be estimated by considering the addition and subtraction as discussed above over the accounted quantity of water supplied by water authority as below:

Net quantity of sewage = Accounted quantity of water supplied from the water works +  
Addition due to unaccounted private water supplies +  
Addition due to infiltration –  
Subtraction due to water losses –  
Subtraction due to water not entering the sewerage system

Generally, 75 to 80% of accounted water supplied is considered as quantity of sewage produced.

**Variation in sewage flow:**

- Variation occurs in the flow of sewage over annual average daily flow. Fluctuation in flow occurs from hour to hour and from season to season.
- The typical hourly variation in the sewage flow is shown in the Figure 11.1. If the flow is gauged near its origin, the peak flow will be quite pronounced. The peak will defer if the sewage has to travel long distance.
- This is because of the time required in collecting sufficient quantity of sewage required to fill the sewers and time required in travelling.
- As sewage flow in sewer lines, more and more sewage is mixed in it due to continuous increase in the area being served by the sewer line.
- This leads to reduction in the fluctuations in the sewage flow and the lag period goes on increasing.
- The magnitude of variation in the sewage quantity varies from place to place and it is very difficult to predict.
- For smaller township this variation will be more pronounced due to lower length and travel time before sewage reach to the main sewer and for large cities this variation will be less.

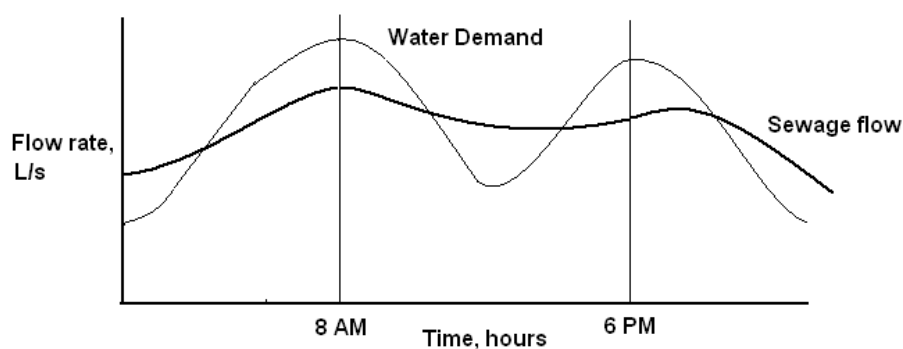

**Typical hourly variations in sewage flow**

**Figure 11.1**



For estimating design discharge following relation can be considered:

Maximum daily flow = Two times the annual average daily flow  
(Representing seasonal variations)

Maximum hourly flow = 1.5 times the maximum daily flow  
(Accounting hourly variations)  
= Three times the annual average daily flow

As the tributary area increases, peak hourly flow will decrease. For smaller population served (less than 50000) the peak factor can be 2.5, and as the population served increases its value reduces. For large cities it can be considered about 1.5 to 2.0. Therefore, for outfall sewer the peak flow can be considered as 1.5 times the annual average daily flow. Even for design of the treatment facility, the peak factor is considered as 1.5 times the annual average daily flow.

The minimum flow passing through sewers is also important to develop self cleansing velocity to avoid silting in sewers. This flow will generate in the sewers during late night hours. The effect of this flow is more pronounced on lateral sewers than the main sewers. Sewers must be checked for minimum velocity as follows:

Minimum daily flow =  $\frac{2}{3}$  Annual average daily flow  
Minimum hourly flow =  $\frac{1}{2}$  minimum daily flow  
=  $\frac{1}{3}$  Annual average daily flow

The overall variation between the maximum and minimum flow is more in the laterals and less in the main or trunk sewers. This ratio may be more than 6 for laterals and about 2 to 3 in case of main sewers.

### **Design Period:**

The future period for which the provision is made in designing the capacities of the various components of the sewerage scheme is known as the design period. The design period depends upon the following:

- Ease and difficulty in expansion.
- Amount and availability of investment.
- Anticipated rate of population growth, including shifts in communities, industries and commercial investments.
- Hydraulic constraints of the systems designed, and
- Life of the material and equipment.

Following design period can be considered for different components of sewerage scheme.

1. Trunk or main sewers: 40 to 50 years
2. Treatment Units: 15 to 20 years
3. Pumping plant: 5 to 10 years

**Design Discharge of sewage:**

The total quantity of sewage generated per day is estimated as product of forecasted population at the end of design period considering per capita sewage generation and appropriate peak factor. The per capita sewage generation can be considered as 75 to 80% of the per capita water supplied per day. The increase in population also result in increase in per capita water demand and hence, per capita production of sewage. This increase in water demand occurs due to increase in living standards, betterment in economical condition, changes in habit of people, and enhanced demand for public utilities.

**Problem:**

A city has a projected population of 60,000 spread over area of 50 hectare. Find the design discharge for the separate sewer line by assuming rate of water supply of 250 LPCD and out of this total supply only 75 % reaches in sewer as wastewater. Make necessary assumption whenever necessary.

**Solution:**

Given data

$$Q = 250 \text{ lit/capita/day}$$

Sewage flow = 75% of water supply

$$= 0.75 \times 250$$

$$= 187.5 \text{ LPCD}$$

$$\text{Total sewage generated} = 187.5 \times 60000 \times \frac{1}{24 \times 3600}$$

$$= 130.21 \text{ lit/sec}$$

$$= 0.13 \text{ m}^3/\text{s}$$

Assume peak factor = 2

$$\text{Total design discharge} = 0.26 \text{ m}^3/\text{s}.$$

**Factors affecting the quantity of storm water:**

The surface run-off resulting after precipitation contributes to the storm water. The quantity of storm water reaching to the sewers or drains is very large as compared with sanitary sewage. The factors affecting the quantity of storm water flow are as below:

- Area of the catchment
- Slope and shape of the catchment area
- Porosity of the soil
- Obstruction in the flow of water as trees, fields, gardens, etc.
- Initial state of catchment area with respect to wetness.
- Intensity and duration of rainfall
- Atmospheric temperature and humidity
- Number and size of ditches present in the area

**Measurement of rainfall:**

The rainfall intensity could be measured by using rain gauges and recording the amount of rain falling in unit time. The rainfall intensity is usually expressed as mm/hour or cm/hour. The rain gauges used can be manual recording type or automatic recording rain gauges.

**Methods for estimation of quantity of storm water:**

1. Rational Method
2. Empirical formulae method

In both the above methods, the quantity of storm water is considered as function of intensity of rainfall, coefficient of runoff and area of catchment.

**Time of concentration:**

- The period after which the entire catchment area will start contributing to the runoff is called as the time of concentration.
- The rainfall with duration lesser than the time of concentration will not produce maximum discharge.

- The runoff may not be maximum even when the duration of the rain is more than the time of concentration. This is because in such cases the intensity of rain reduces with the increase in its duration.
- The runoff will be maximum when the duration of rainfall is equal to the time of concentration and is called as *critical rainfall duration*. The time of concentration is equal to sum of inlet time and time of travel.
- Time of concentration = Inlet time + time of travel

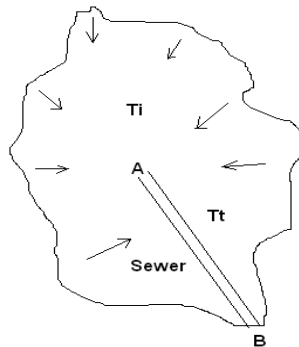

### Runoff from a given catchment

Figure 11.2

#### Inlet Time:

The time required for the rain in falling on the most remote point of the tributary area to flow across the ground surface along the natural drains or gutters up to inlet of sewer is called inlet time (Figure). The inlet time 'Ti' can be estimated using relationships similar to following. These coefficients will have different values for different catchments.

$$T_i = (0.885L^3/H)^{0.385}$$

Where,

T<sub>i</sub> = Time of inlet, minute

L = Length of overland flow in Kilometre from critical point to mouth of drain

H = Total fall of level from the critical point to mouth of drain, meter

#### Time of travel:

The time required by the water to flow in the drain channel from the mouth to the point under consideration or the point of concentration is called as time of travel.

Time of Travel ( $T_t$ ) = Length of drain/ velocity in drain

**Runoff Coefficient:**

The total precipitation falling on any area is dispersed as percolation, evaporation, storage in ponds or reservoir and surface runoff. The runoff coefficient can be defined as a fraction, which is multiplied with the quantity of total rainfall to determine the quantity of rain water, which will reach the sewers. The runoff coefficient depends upon the porosity of soil cover, wetness and ground cover.

The overall runoff coefficient for the catchment area can be worked out as follows:

Overall runoff coefficient,  $C = [A_1.C_1 + A_2.C_2 + \dots + A_n.C_n] / [A_1 + A_2 + \dots + A_n]$

Where,  $A_1, A_2 \dots A_n$  are types of area with  $C_1, C_2 \dots C_n$  as their coefficient of runoff, respectively.

The typical runoff coefficient for the different ground cover is provided in the following table:

Type of Cover	Coefficient of runoff
Business areas	0.70 – 0.90
Apartment areas	0.50 – 0.70
Single family area	0.30 – 0.50
Parks, Playgrounds, Lawns	0.10 – 0.25
Paved Streets	0.80 – 0.90
Water tight roofs	0.70 – 0.95

**Rational Method:**

Storm water quantity can be estimated by rational method as below:

Storm water quantity,  $Q = C.I.A / 360$

Where,

$Q$  = Quantity of storm water,  $m^3/sec$

$C$  = Coefficient of runoff

$I$  = intensity of rainfall (mm/hour) for the duration equal to time of concentration, and

$A$  = Drainage area in hectares

OR

$Q = 0.278 C.I.A$

Where,  $Q$  is  $m^3/sec$ ;  $I$  is mm/hour, and  $A$  is area in square kilometre.

**Empirical Formula:**

Empirical formulae are used for determination of runoff from very large area. Various empirical relationships are developed based on the past observations on specific site conditions suiting a particular region. These empirical formulae can be used for prediction of storm water runoff for that particular catchment.

(a) Burkli – Zeiglar formula

$$Q = \frac{CIA}{141.58} \sqrt[4]{S/A}$$

(b) Mc Math formula

$$Q = \frac{CIA}{148.35} \sqrt[5]{S/A}$$

(c) Fuller’s formula

$$Q = \frac{CM^{0.8}}{13.23}$$

(Where, *S*- Slope of the area in meter per thousand meter, *M*- drainage area in sq. Km, *A* = drainage area in hectare)

**Empirical formula for rainfall intensities:**

The intensity of rainfall can be worked out from the rainfall records of the area under consideration. The rainfall intensity may be taken from rainfall records of that area for which storm sewers are to be designed.

In case where rainfall records are not available the intensity of rainfall is obtained by applying suitable empirical formula.

(a) General formula:

$$i = \frac{25.4a}{t+b}$$

Where *i* = intensity of rainfall in mm/hr.

*t* = duration of storm in minutes

*a* & *b* are constants

According to Ministry of Health, U.S.A the values of constant *a* and *b* are as follows:

- *a* = 30 and *b* = 10 when duration of storm is 5 to 20 minutes
- *a* = 40 and *b* = 20 when duration of storm is 20 to 100 minutes

(b) for localities where rainfall is frequent

$$i = \frac{3430}{t+18}$$

where  $i$  and  $t$  are as above.

This formula is adopted for area having heavy and frequent rainfall. It gives intensity of rainfall which will occur once in 5 yrs or so.

(c) For storms occurring once in 10 yrs.

$$i = \frac{180}{\sqrt{t}}$$

(d) For storms occurring once in a year

$$i = 150/t^{0.625}$$

where  $i$  and  $t$  are as above.

(e) Kuichling's formula:

$$i = \frac{2667}{t+20} \text{ for storms occurring once in 10 yrs}$$

$$i = \frac{3048}{t+20} \text{ for storms occurring once in 15 yrs}$$

### **Design of sewers:**

Generally, sewers are laid at steeper gradients falling towards the outfall point with circular pipe cross section. Storm water drains are separately constructed as surface drains at suitable gradient, either rectangular or trapezoidal section. Sewers are designed to carry the maximum quantity of sanitary sewage likely to be produced from the area contributing to the particular sewer. Storm water drains are designed to carry the maximum storm runoff that is likely to be produced by the contributing catchment area from a rain of design frequency and of duration equal to the time of concentration.

### **Requirements of Design and Planning of Sewerage System:**

The sewerage scheme is designed to remove entire sewage effectively and efficiently from the houses to the point of treatment and disposal. Following aspects should be considered while designing the system.

- The sewers provided should be adequate in size to avoid overflow and possible health hazards.
- For evaluating proper diameter of the sewer, correct estimation of sewage discharge is necessary.

- The flow velocity inside the sewer should neither be so large as to require heavy excavation and high lift pumping, nor should be so small causing deposition of the solid in the sewers.
- The sewers should be laid at least 2 to 3 m deep to carry sewage from basement.
- The sewage in sewer should flow under gravity with 0.5 to 0.8 full at designed discharge, i.e. at the maximum estimated discharge.
- The sewage is conveyed to the point usually located in low-lying area, where the treatment plant is located.
- Treatment plant should be designed taking into consideration the quality of raw sewage expected and to meet the discharge standards.

**Difference between Water Supply Pipes and Sewer Pipes:**

<b>Water Supply Pipes</b>	<b>Sewer Pipes</b>
It carries pure water.	It carries contaminated water containing organic or inorganic solids which may settle in the pipe. It can cause corrosion of the pipe material.
Velocity higher than self-cleansing is not essential, because of solids are not present in suspension.	To avoid deposition of solids in the pipes Self-cleansing velocity is necessary at all possible discharge.
It carries water under pressure. Hence, the pipe can be laid up and down the hills and the valleys within certain limits.	It carries sewage under gravity. Therefore it is required to be laid at a continuous falling gradient in the downward direction towards outfall point.
These pipes are flowing full under pressure.	Sewers are design to run partial full at maximum discharge. This extra space ensures non-pressure gravity flow. This will minimize the leakage from sewer, from the faulty joints or crack, if any.



### Hydraulic Formulae for Determining Flow Velocities:

Sewers of any shape are hydraulically designed as open channels, except in the case of inverted siphons and discharge lines of pumping stations. Following formulae can be used for design of sewers.

#### (1) Manning's Formula

This is most commonly used for design of sewers. The velocity of flow through sewers can be determined using Manning's formula as below:

$$V = \frac{1}{n} r^{\frac{2}{3}} \times s^{1/2}$$

Where  $V$  = velocity of flow in the sewer, m/sec

$r$  = Hydraulic mean depth of flow, m

$$= a/p$$

$a$  = Cross section area of flow, m<sup>2</sup>

$p$  = Wetted perimeter, m

$n$  = Rugosity coefficient, depends upon the type of the channel surface i.e., material and lies between 0.011 and 0.015. For brick sewer it could be 0.017 and 0.03 for stone facing sewers.

$s$  = Hydraulic gradient, equal to invert slope for uniform flows.

#### (2) Chezy's Formula:

$$V = C r^{1/2} s^{1/2}$$

Where,  $C$  is Chezy's constant and remaining variables are same as above equation.

#### (3) Crimp and Burge's Formula:

$$V = 83.5 r^{2/3} s^{1/2}$$

#### (4) Hazen- Williams Formula:

$$V = 0.849 C r^{0.63} s^{0.54}$$

The Hazen-Williams coefficient ' $C$ ' varies with life of the pipe and it has high value when the pipe is new and lower value for older pipes. For example for RCC new pipe it is 150 and the value recommended for design is 120, as the pipe interior may become rough with time. The design values of ' $C$ '; for AC pipes, Plastic pipes, CI pipes, and steel lined with cement are 120, 120, 100, and 120, respectively. Modified Hazen-William's equation is also used in practice.

### Minimum Velocity: Self Cleansing Velocity

- The velocity that would not permit the solids to settle down and even scour the deposited particles of a given size is called as self-cleansing velocity.
- This minimum velocity should at least develop once in a day so as not to allow any deposition in the sewers.
- Otherwise, if such deposition takes place, it will obstruct free flow causing further deposition and finally leading to the complete blocking of the sewers.

This minimum velocity or self-cleansing velocity can be worked out as below:

$$V_s = \sqrt{\frac{8K}{f'}(Ss - 1)g \times d'}$$

Where  $K$  = constant, for clean inorganic solids = 0.04 and for organic solids = 0.06

$f'$  = Darcy Weisbach friction factor (for sewers = 0.03)

$Ss$  = Specific gravity of sediments

$g$  = gravity acceleration

$d'$  = diameter of grain, m

- Hence, for removing the impurities present in sewage i.e., sand up to 1 mm diameter with specific gravity 2.65 and organic particles up to 5 mm diameter with specific gravity of 1.2, it is necessary that a minimum velocity of about 0.45 m/sec and an average velocity of about 0.9 m/sec should be developed in sewers.
- Hence, while finalizing the sizes and gradients of the sewers, they must be checked for the minimum velocity that would be generated at minimum discharge, i.e., about 1/3 of the average discharge.
- While designing the sewers the flow velocity at full depth is generally kept at about 0.8 m/sec or so. Since, sewers are generally designed for 1/2 to 3/4 full, the velocity at 'designed discharge' (i.e., 1/2 to 3/4 full) will even be more than 0.8 m/sec. Thus, the minimum velocity generated in sewers will help in the following ways:

(1) Adequate transportation of suspended solids.

- (2) Keeping the sewer size under control; and
- (3) Preventing the sewage from decomposition by moving it faster, thereby preventing evolution of foul gases.

**Maximum Velocity or Non-scouring Velocity**

- The interior surface of the sewer pipe gets scored due to the continuous abrasion caused by suspended solids present in sewage.
- The scoring is pronounced at higher velocity than what can be tolerated by the pipe materials. This wear and tear of the sewer pipes will reduce the life span of the pipe and their carrying capacity.
- In order to avoid this, it is necessary to limit the maximum velocity that will be produced in sewer pipe at any time. This limiting or non scouring velocity mainly depends upon the material of sewer.

Limiting or non-scouring velocity for different sewer material

Sewer Material	Limiting velocity, m/sec
Vitrified tiles	4.5 – 5.5
Cast iron sewer	3.5 – 4.5
Cement concrete	2.5 – 3.0
Stone ware sewer	3.0 – 4.5
Brick lined sewer	1.5 – 2.5

- The problem of maximum or non-scouring velocity is severe in hilly areas where ground slope is very steep and this is overcome by constructing drop manholes at suitable places along the length of the sewer.

**Sizes of sewers:**

- The minimum size of a sewer depends upon the practice followed in the locality.
- Usually the sewers of 100 mm diameter are allowed up to a maximum length of 6 metres or so.
- But when the length of sewer line exceeds about 6 metre a sewer of minimum diameter 150 mm is allowed.

- The smaller the diameter of sewer the greater will be the slope and hence in order to take advantage of available fall the sewers of larger diameter are sometimes used.

**Design Procedure:**

In the design of sewers, the following procedure is generally adopted:

- (a) Formation of zones: The area to be served by the drainage system is divided into different zones. The general layout of roads is to be properly studied for the location of sewers. The zones are marked on the map and contours are also drawn on the map.
- (b) Arrangement of sewers: The proposed arrangement for sewers for different zones is then worked out. The low lying areas are isolated and pumping stations are installed for them. The flow of sewage starts from high level zones. The various sewers such as branch sewers, main sewers, trunk sewers, outfall sewers etc. are marked on the map.
- (c) Quantity of sewage: Depending upon the type of sewer i.e. separate or combined sewer, the quantity of sewage to be carried by the sewer is determined. After proper study of variations in rate of sewage, a suitable multiplying factor is applied to arrive at the quantity of sewage for which sewer is to be designed.
- (d) Velocity of flow: A suitable value for the velocity of flow is then determined. This value should fall between the minimum and maximum limits i.e. between self – cleansing and non- scouring velocities.
- (e) Section of sewer: The section of sewer is then easily worked out by the relation:

Quantity of sewage = sectional area of sewer x velocity of flow

$$Q = A \times V$$

- (f) Gradient: The slope of sewer line is worked out and longitudinal sections of each sewer are drawn to a suitable scale.

**Variation in flow and velocities:**

The sewage discharge flowing through a sewer does not remain constant at all the times. For most of the period the sewer does not run full. When the sewer does not run full, there is a variation in discharge, depth of flow, hydraulic mean depth, velocity etc.

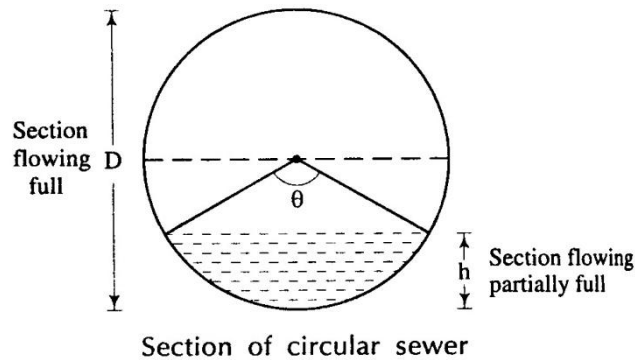

Figure 11.3

As shown in figure 11.3,  $D$  = diameter of circular sewer

$h$  = depth of flow when sewer is flowing partially full

$\theta$  = angle subtended at the centre when flowing partially full

(1) When the section is flowing full, the hydraulic parameters will be as follows:

$$\text{Cross sectional area} = A = \frac{\pi D^2}{4}$$

$$\text{Wetted perimeter } P = \pi D$$

$$\text{Velocity of flow} = v$$

$$\text{Discharge } Q = A \times v$$

(2) When the section is flowing partially full the hydraulic parameters will be as follows:

$$\text{Depth of partial flow} = h = \frac{D}{2} \left( 1 - \frac{\cos \theta}{2} \right)$$

$$\text{Proportional depth} = h/D = 1/2 \left( 1 - \frac{\cos \theta}{2} \right)$$

$$\text{Cross sectional area when flowing partially full} = a$$

$$\begin{aligned} a &= \left( \frac{\pi D^2}{4} \times \frac{\theta}{360} \right) - \left( \frac{D \cos \theta}{2} \right) \left( \frac{D \sin \theta}{2} \right) \\ &= \frac{D^2}{4} \left( \frac{\pi \theta}{360} - \frac{\sin \theta}{2} \right) \end{aligned}$$

$$\text{Proportional area} = a/A = \frac{\theta}{360} - \frac{\sin \theta}{2\pi}$$

$$p = \text{partial wetted perimeter}$$

$$= \frac{\pi D \theta}{360}$$

$$\text{Proportionate wetted perimeter} = p/P = \frac{\theta}{360}$$

$$\begin{aligned} m &= \text{hydraulic mean depth} \\ &= \text{area/ perimeter} \end{aligned}$$

Proportionate hydraulic mean depth = proportionate area/ proportionate perimeter

$$\begin{aligned} &= \frac{\frac{\theta}{360} \frac{\sin\theta}{2\pi}}{\frac{\theta}{360}} \\ &= 1 - 360^\circ \frac{\sin\theta}{2\pi\theta} \end{aligned}$$

According to Manning's formula

$$V = r^{2/3} s^{1/2}/n$$

Where  $r$  = hydraulic mean depth

$$\begin{aligned} \text{Proportionate velocity} &= (\text{Proportionate hydraulic mean depth})^{2/3} \\ &= \left(1 - 360^\circ \frac{\sin\theta}{2\pi\theta}\right)^{2/3} \end{aligned}$$

Proportionate discharge =  $q/Q = av/AV$

$$\begin{aligned} &= (\text{proportionate area}) (\text{proportionate velocity}) \\ &= \left(\frac{\theta}{360} - \frac{\sin\theta}{2\pi}\right) \left(1 - 360^\circ \frac{\sin\theta}{2\pi\theta}\right)^{2/3} \end{aligned}$$

### Effect of Flow Variations on Velocities in a Sewer:

- The discharge flowing through sewers varies considerably from time to time. Hence, there occur variation in depth of flow and thus, variation in Hydraulic Mean Depth (H.M.D.).
- Due to change in H.M.D. there occur changes in flow velocity, because it is proportional to (H.M.D.)<sup>2/3</sup>.
- Therefore, it is necessary to check the sewer for minimum velocity of about 0.45 m/sec at the time of minimum flow (1/3 of average flow) and the velocity of about 0.9 to 1.2 m/sec should be developed at a time of average flow.

- The velocity should also be checked for limiting velocity i.e. non-scouring velocity at the maximum discharge.
- For flat ground sewers are designed for self-cleansing velocity at maximum discharge. This will permit flatter gradient for sewers.
- For mild slopping ground, the condition of developing self-cleansing velocity at average flow may be economical. Whereas, in hilly areas, sewers can be designed for self cleansing velocity at minimum discharge, but the design must be checked for non-scouring velocity at maximum discharge.

**Problem 1:** Calculate the velocity of flow in a sewer of diameter 1.2 m. The sewer is laid at a gradient of 1 in 400. What will be the discharge through this sewer when running one – half full. Assume  $n = 0.012$  in Manning’s formula.

**Solution:**

According to Manning’s formula,

$$V = \frac{1}{n} r^{\frac{2}{3}} \times s^{1/2}$$

Where,  $n = 0.012$

$$\begin{aligned} r &= a/p \\ &= d/4 \end{aligned}$$

Where  $d$  = diameter of pipe

$$\begin{aligned} &= 1.2/4 \\ &= 0.3 \text{ m} \end{aligned}$$

$$s = 1/400$$

$$\begin{aligned} \text{Substituting, } v &= (0.3)^{2/3} (1/400)^{1/2} / 0.012 \\ &= 1.867 \text{ m per second} \end{aligned}$$

$$\begin{aligned} Q &= \frac{1}{2} \frac{\pi (1.2)^2}{4} \times 1.867 \\ &= 1.056 \text{ m}^3 \text{ per second.} \end{aligned}$$

**Problem 2:** Calculate the velocity, discharge and Chezy’s coefficient for a stoneware sewer running full. The diameter of sewer is 150 mm and it is laid at a gradient of 1 in 60. Assume  $n = 0.013$  in Manning’s formula.

**Solution:** According to Manning's formula

$$v = \frac{1}{n} r^{\frac{2}{3}} \times s^{1/2}$$

Where  $v$  = velocity of flow in m per second

$$n = 0.013$$

$r$  = hydraulic mean depth in meters

$$= d/4 \text{ for pipe running full}$$

$$= 0.15/4$$

$$= 3/80 \text{ m}$$

$$i = 1/60$$

Substituting 
$$v = \frac{1}{0.013} \times \left(\frac{3}{80}\right)^{\frac{2}{3}} \times \left(\frac{1}{60}\right)^{\frac{1}{2}}$$
$$= 1.113 \text{ m per second}$$

Then  $Q = Av$

Where  $Q$  = discharge in  $\text{m}^3$  per second

$A$  = cross sectional area of sewer

$$= \frac{\pi(0.15)^2}{4} \text{ m}^2$$

$$v = 1.113 \text{ m per second}$$

Substituting 
$$Q = \frac{\pi(0.15)^2}{4} \times 1.113$$
$$= 0.02 \text{ m}^3 \text{ per second}$$

According to Chezy's formula

$$v = C r^{1/2} s^{1/2}$$

Here  $v = 1.113 \text{ m per second}$

$$r = 3/80 \text{ m}$$

$$s = 1/60$$

Substituting 
$$1.113 = C (3/80)^{1/2} (1/60)^{1/2}$$
$$C = 1.113 \times 40$$
$$= 44.52$$



**Problem: 3** Determine the size of a circular sewer for a discharge of 600 litres per second running half full. Assume slope = 1 in 10000 and  $n = 0.015$  in Manning's formula.

**Solution:** As sewer is running half full

$$\text{Proportionate depth} = \frac{1}{2}(1 - \cos\theta/2)$$

$$0.5 = \frac{1}{2}(1 - \cos\theta/2)$$

$$\cos\frac{\theta}{2} = 0$$

$$\frac{\theta}{2} = 90$$

$$\theta = 180$$

Partial cross sectional area

$$\begin{aligned} a &= \frac{D^2}{4} \left( \frac{\pi\theta}{360} - \frac{\sin\theta}{2} \right) \\ &= \frac{D^2}{4} \left( \frac{\pi}{2} - 0 \right) \\ &= \frac{\pi D^2}{8} \end{aligned}$$

Partial wetted perimeter

$$\begin{aligned} p &= \pi D \theta / 360 \\ &= \frac{\pi D}{2} \end{aligned}$$

Hydraulic mean depth

$$\begin{aligned} r &= a/p \\ &= D/4 \end{aligned}$$

Using Manning's formula

$$v = \frac{1}{n} r^{\frac{2}{3}} \times S^{1/2}$$

where  $v$  = velocity of flow in meter per second

$$= q/a$$

$q$  = discharge in  $\text{m}^3$  per second

$$= 600/1000$$

$$= 0.6 \text{ m}^3 \text{ per second}$$

$$v = \frac{0.6}{\frac{\pi D^2}{8}} = 4.8/\pi D^2$$

$$n = 0.015$$

$$r = D/4$$

$$s = 0.0001$$

substituting  $4.8/\pi D^2 = \frac{1}{0.015} \times (D/4)^{\frac{2}{3}} \times (0.0001)^{1/2}$

$$D = 1.93 \text{ m}$$

Provide a circular sewer of diameter 2 m.

## CHAPTER-12

# SEWERAGE SYSTEM

### System of sewerage:

Following are the three system of sewerage

- Separate system
- Combined system
- Partially separate system

### Separate system:-

In this system, the two sets of sewers are laid- one for carrying sewage and the other for carrying storm water. The sewage is carried to the treatment plant and the storm water is directly discharged into the natural outlet in the form of river or stream.

### Advantages:-

1. The load on treatment unit becomes less.
2. The sewers are small in size.
3. The storm water can be discharged into natural streams without any treatment.
4. The natural water is not unnecessarily polluted as the storm water is not foul in nature.

### Disadvantages:-

1. The cleaning of sewer is difficult as they are of small size.
2. The system requires two sets of sewer and hence it may prove to be costly.
3. The sewer line carrying the storm water remains idle in dry period. So it may be clogged by garbage in that period.

### Combined system:-

In this system, only one set of sewer is laid and it carries both, namely, sewage and storm water. The sewage and storm water are carried to the sewage treatment plant.

### Advantages:-

1. It is easy to clean a combined sewer as it is of large size.
2. The storm water reduces the strength of sewage by dilution.
3. This system requires only one set of sewer and it may thus prove to be economical.

### Disadvantages:-

1. During extraordinary heavy storms, the combined sewer may overflow and it may thus put public health in danger.

2. The combined sewer, if not properly designed, gets easily silted.
3. The sewers are large in diameter.
4. The treatment plant is unnecessarily loaded with the combined volume of sewage and storm water .it may exceed the normal capacity of the plant.

**Partially separate system:-**

This system consists of two sewer lines, one is of large diameter for carrying sewage and the other is of smaller diameter for carrying storm water only. When it rains, the storm water, at the beginning is allowed to flow with the sewage through the large sewer line. When the rain continues for a long time then the excess storm water is diverted to the smaller sewer line to discharge in the river directly. Thus the load on the treatment plant is controlled and kept within the permissible capacity of the plant.

**Advantages:-**

1. The entry of storm water avoiding silting in sewers.
2. The sewers are of reasonable size.
3. It reduces the load on the treatment plant and the excess storm water may be safely discharged in the river.
4. The storm water from individual houses may be safely disposed of to the large sewer.

**Disadvantages:-**

1. The smaller sewer remains idle in dry season.
2. If the division of storm water is not done at proper time, then it may create unnecessary trouble both in the treatment plant and in the streets.

**Shapes of sewer:**

Generally, the circular shaped sewers are adopted. The advantages of circular sewer are:

1. The perimeter of circular sewer is the least with respect to the sewer of other shape.
2. The inner surface is smooth hence the flow of sewage is uniform and there is no chance of deposition of suspended particle.
3. The circular sewer is easy to construct.

The following are the non circular sewers that are commonly adopted:

**(1) Basket-Handle section:**

In this sewer, the outer surface is circular. The inner surface is divided into two portions.

As shown in figure 12.1, the upper portion resembles a basket handle and the lower portion is like a channel. During dry season the sewage flows through the lower portion and during monsoon the combined sewage flows through the full section.

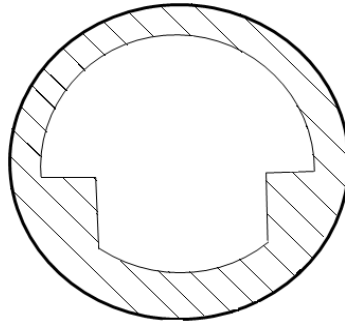

**Figure 12.1**

**(2) Egg-shaped section:**

The egg-shaped section sewers may be of two types such as normal egg shaped and inverted egg shaped. Both the sections are suitable for carrying D.W.F and combined sewage.

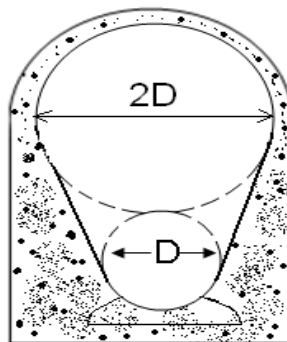

**Figure 12.2**

**(3) Horse shoe section:**

This type of sewer is constructed for carrying heavy discharge. This is like a tunnel and resembles a horse-shoe, as shown in figure 12.3. The size is so large that the maintenance works within the sewer are very easy.

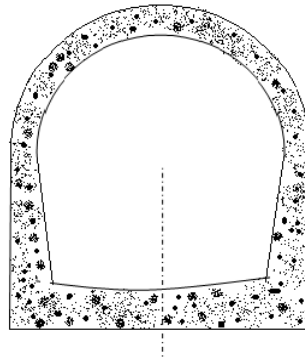

**Figure 12.3**

**(4) Parabolic section:**

As shown in figure 12.4 the upper surface of the sewer is in the shape of a parabola and the invert is in the shape of an ellipse. This type of sewer is suitable for carrying small discharge.

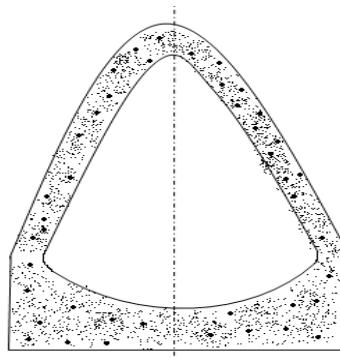

**Figure 12.4**

**(5) Rectangular section:**

This type of sewer can be easily constructed. These are suitable for large sewers to carry heavy discharge of sewage. The maintenance works are easy in this section.

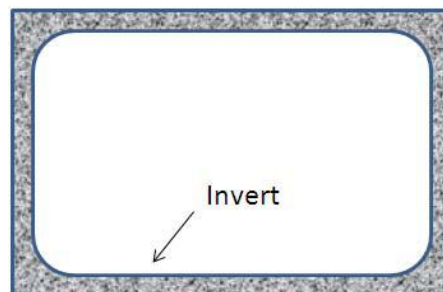

**Figure 12.5**

**(6) U-shaped section:**

As shown in figure 12.6 this type of sewer resembles the letter “U”. This type of sewer is suitable for carrying heavy discharge. The maintenance works are easy in this section.

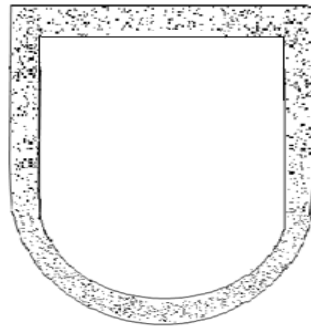

**Figure 12.6**

**Important Factors Considered for Selecting Material for Sewer**

Following factors should be considered before selecting material for manufacturing sewer pipes:

**a. Resistance to corrosion**

Sewer carries wastewater that releases gases such as H<sub>2</sub>S. This gas in contact with moisture can be converted into sulphuric acid. The formation of acids can lead to the corrosion of sewer pipe. Hence, selection of corrosion resistance material is must for long life of pipe.

**b. Resistance to abrasion**

Sewage contain considerable amount of suspended solids, part of which are inorganic solids such as sand or grit. These particles moving at high velocity can cause wear and tear of sewer pipe internally. This abrasion can reduce thickness of pipe and reduces hydraulic efficiency of the sewer by making the interior surface rough.

**c. Strength and durability**

The sewer pipe should have sufficient strength to withstand all the forces that are likely to come on them. Sewers are subjected to considerable external loads of backfill material and traffic load, if any. They are not subjected to internal pressure of water. To withstand external load safely without failure, sufficient wall thickness of

pipe or reinforcement is essential. In addition, the material selected should be durable and should have sufficient resistance against natural weathering action to provide longer life to the pipe.

**d. Weight of the material**

The material selected for sewer should have less specific weight, which will make pipe light in weight. The lightweight pipes are easy for handling and transport.

**e. Imperviousness**

To eliminate chances of sewage seepage from sewer to surrounding, the material selected for pipe should be impervious.

**f. Economy and cost**

Sewer should be less costly to make the sewerage scheme economical.

**g. Hydraulically efficient**

The sewer shall have smooth interior surface to have less frictional coefficient.

**Materials for Sewers**

Following are the various materials which are used for sewers:

**(1) Asbestos Cement Sewers**

- These are manufactured from a mixture of asbestos fibres, silica and cement. Asbestos fibres are thoroughly mixed with cement to act as reinforcement.
- These pipes are available in size 10 to 100 cm internal diameter and length up to 4.0 m.
- The pipe and joints are resistant to corrosion.
- These pipes are used for vertical transport of water. For example, transport of rainwater from roofs in multi-storeyed buildings, for transport of sewage to ground, and for transport of less foul sullage i.e., wastewater from kitchen and bathroom.

**Advantages**

- These pipes are light in weight and hence, easy to carry and transport.
- Easy to cut and assemble without skilled labour.

**Disadvantages**

- These pipes are structurally not very strong.
- These are susceptible to corrosion by sulphuric acid. When bacteria produce H<sub>2</sub>S, in presence of water, H<sub>2</sub>SO<sub>4</sub> can be formed leading to corrosion of pipe material.



**(2) Plain Cement Concrete or Reinforced Cement Concrete sewer**

- Plain cement concrete (1: 1.5: 3) pipes are available up to 0.45 m diameter and reinforcement cement pipes are available up to 1.8 m diameter. These pipes can be cast in situ or precast pipes.
- Precast pipes are better in quality than the cast in situ pipes.
- The reinforcement in these pipes can be different such as single cage reinforced pipes, used for internal pressure less than 0.8 m; double cage reinforced pipes used for both internal and external pressure greater than 0.8 m
- Elliptical cage reinforced pipes used for larger diameter sewers subjected to external pressure.
- The cement concrete sewers can be prepared either at site or at factory. In any case, the cement concrete sewers should be of correct shape, free from cracks, fractures or any other defects and they should give a clear ringing sound when struck with a hammer.
- The factory made products are known as the pre-cast concrete sewers. The plain pre-cast concrete sewers are generally avoided and only R.C.C. pre-cast concrete sewers are used.
- The cast-in-situ R.C.C. sewers are constructed where it is more economical or when non- standard sections are required.

**Advantages of concrete pipes**

- Strong in tension as well as compression.
- Resistant to erosion and abrasion.
- They can be made of any desired strength.
- Easily moulded, and can be in situ or precast pipes.
- Economical for medium and large sizes.

**Disadvantages of concrete pipes**

- The carrying capacity of the pipe reduces with time because of corrosion.
- The pipes are susceptible to erosion by sewage containing silt and grit.

The concrete sewers can be protected internally by vitrified clay linings. With protection lining they are used for almost all the branch and main sewers. Only high alumina cement concrete should be used when pipes are exposed to corrosive liquid like sewage.

### (3) **Vitrified Clay or Stoneware Sewers**

These pipes are used for house connections as well as lateral sewers. The size of the pipe available is 5 cm to 30 cm internal diameter with length 0.9 to 1.2 m. These pipes are rarely manufactured for diameter greater than 90 cm. These are joined by bell and spigot flexible compression joints.

#### **Advantages**

- Resistant to corrosion, hence fit for carrying polluted water such as sewage.
- Interior surface is smooth and is hydraulically efficient.
- The pipes are highly impervious.
- Strong in compression.
- These pipes are durable and economical for small diameters.

#### **Disadvantages**

- Heavy, bulky and brittle and hence, difficult to transport.
- These pipes cannot be used as pressure pipes, because they are weak in tension.
- These require large number of joints as the individual pipe length is small.

### (4) **Cast Iron Sewers**

- These pipes are stronger and capable to withstand greater tensile, compressive, as well as bending stresses. However, these are costly.
- Cast iron pipes are used for outfall sewers, rising mains of pumping stations, and inverted siphons, where pipes are running under pressure.
- These are also suitable for sewers under heavy traffic load, such as sewers below railways and highways.
- They form 100% leak proof sewer line to avoid groundwater contamination.
- They are less resistant to corrosion; hence, generally lined from inside with cement concrete, coal tar paint, epoxy, etc.

**(5) Steel Pipes**

- These are used under the situations such as pressure main sewers, under water crossing, bridge crossing, necessary connections for pumping stations, laying pipes over self supporting spans, railway crossings, etc.
- They can withstand internal pressure, impact load and vibrations much better than CI pipes.
- They are more ductile and can withstand water hammer pressure better.
- They are susceptible to corrosion and are not generally used for partially flowing sewers.

**(6) Plastic sewers (PVC pipes)**

- Plastic is recent material used for sewer pipes. These are used for internal drainage works in house.
- These are available in sizes 75 to 315 mm external diameter and used in drainage works.
- They offer smooth internal surface.
- The additional advantages they offer are resistant to corrosion, light weight of pipe, economical in laying, jointing and maintenance, the pipe is tough and rigid, and ease in fabrication and transport of these pipes.

**Laying of sewer**

**(1) Making centre lines of sewers:-**

- The centre lines of sewers are marked on the streets and roads from the plan starting from the lowest point or the outfall of the main proceeding upwards.
- The setting out of work is done by means of chain and theodolite and compass.
- For checking the centre line during construction generally wooden pegs are driven at 10 metres interval on a line parallel to the centre line at such a distance where while laying sewers, they will not disturb them.
- For checking the levels of the sewer pipe and their alignment temporary bench marks are established at 200-400 metre interval.
- On the centre line of sewers the positions of the sewer appurtenances are also marked as per the plan which have been finalised.

**(2) Excavation of trenches:-**

- As in most of the towns the need of sewerage occurs after the development of the town i.e. when its roads, streets are constructed, laying the sewer line is usually done along the sides of the streets or in its middle.
- Therefore after marking the layout of the sewer lines on the ground, the first step is the removal of pavement.
- The removal of the pavement is started from the lower end of the sewers and proceeds upward.
- After removing pavement the excavation of trench is started. The excavation of trenches is done manually in India where as in some countries it is done by means of machinery.
- The width of trench depends on the diameter of the sewer and the depth of sewer line below the ground level.
- For large size sewer the trench width should be 15 cm more than the external diameter of the sewer for easiness in lowering and adjusting the sewer pipe.
- The minimum trench width of 60 to 100 cm is necessary for conveniently laying and jointing of even very small size sewer.
- Sometimes in case of small diameter sewer, the trench width is kept about 15 cm larger than the sewer dia but at both the end bigger trench is excavated for jointing the pipes as shown in figure 12.7.

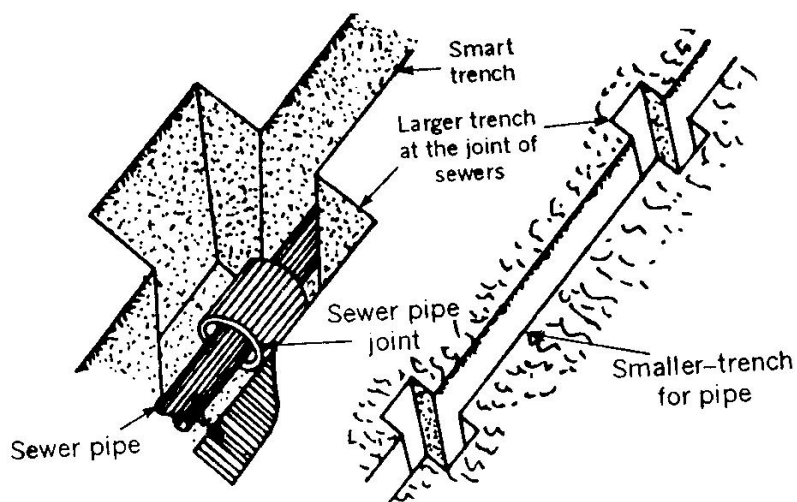

**Excavation of trenches**

**Figure 12.7**

- If the trench has been excavated within one half of the diameter of the sewer pipe from the bottom and in case the soil material is firm, the remaining trench should be excavated in semi circular shape, to conform to the shape of the lower half of the outer side of the pipe.

**(3) Bracing and dewatering of trenches:-**

- In case of hard soils and rocks, the sides of the excavated trench will not collapse and will remain in cut position. But in case of soft soil the trench sides require shoring and strutting to prevent their collapse till the sewer are laid and tested.
- The following are the function of the timbering or shoring:
  - (i) To prevent the collapse of the sides of the trenches.
  - (ii) To reduce the width of the trench at the top to the minimum possible.
  - (iii) To prevent the seepage of the ground water into the trench.
  - (iv)

Various methods of shoring and bracing of trenches have been shown in figure 12.8.

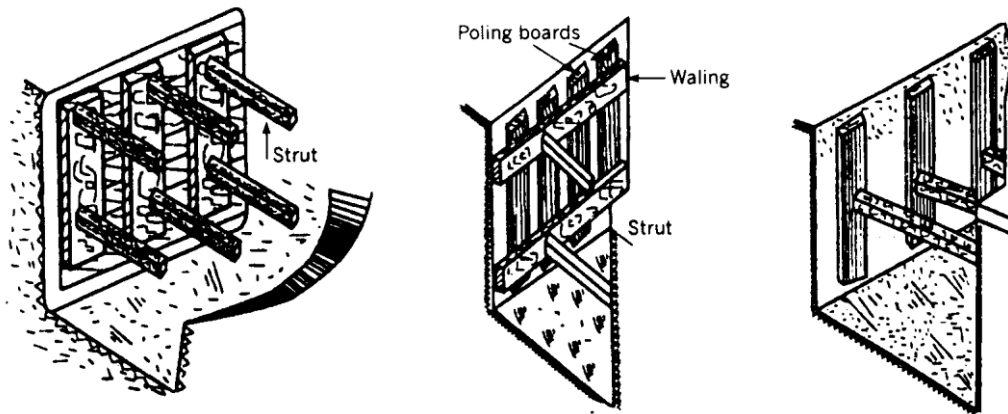

(a) Method of supporting Trench wall in soft soil

(b) Method of supporting trench wall in moderate firm soil

(c) Method of supporting trench wall in firm soil

**Figure 12.8**

When sewer lines are to be laid below the ground water table, the ground water enters the trenches during excavation and causes many difficulties. Therefore the dewatering

of trenches is compulsory under such circumstances. There are various methods for the removal of this water, but most common are:

- **Gravity method:-**

In this method the excavation is started from the lowest level and is done upwards so that whatever water enters the trench it automatically flows towards outlet due to gravity.

- **Pumping method:-**

In this method during excavation the amount of water entering the trench is pumped outside the trenches. In some cases the level of water table is depressed by driving driven wells along trenches and pumping the ground water.

At some places porous pipe is laid below the main sewer line to collect the ground water entering in the trench. This porous pipe carries the seepage water to the water courses. At the sewer construction work is started from the lower level, the water entering the trench must be carried by the sewer constructed. But even if it is not possible to convey the seepage water through the sewer under construction, it may be pumped out.

**(4) Laying of sewers:-**

Trenches are excavated with proper grade so that the sewage may flow in sewers due to gravitational flow only.

Sewer pipes may have to be laid under the following conditions:

- (a) **Culvert condition:** When the pipe is laid under embankment and it projects wholly or partly above the original surface or sub grade.
- (b) **Trench Condition:** When the pipe is laid in a trench excavated for the purpose.
- (c) **Negative projecting condition:** when the pipe is laid in a relatively narrow and shallow trench in such a manner that the top of the pipe is at an elevation below the natural ground surface.
- (d) **Open Condition:** In this condition, the pipe is laid such that it projects wholly or partly above the ground surface.

When a sewer has to be laid in soft underground strata the trench shall be excavated deeper than what is ordinarily required. The trench bottom shall be stabilised by the

addition of course gravel or rock. In case of very bad soil the trench bottom shall be filled in with cement concrete of appropriate grade.

The sewer pipes are not usually laid directly on the soil in the trenches. Before actual laying the bottom of the trench is prepared to receive the pipe such that the load is distributed uniformly. It is always preferred to provide concrete bedding in the trench below the sewer pipes. Figure 12.9 shows various types of pipe beddings usually provided under various conditions.

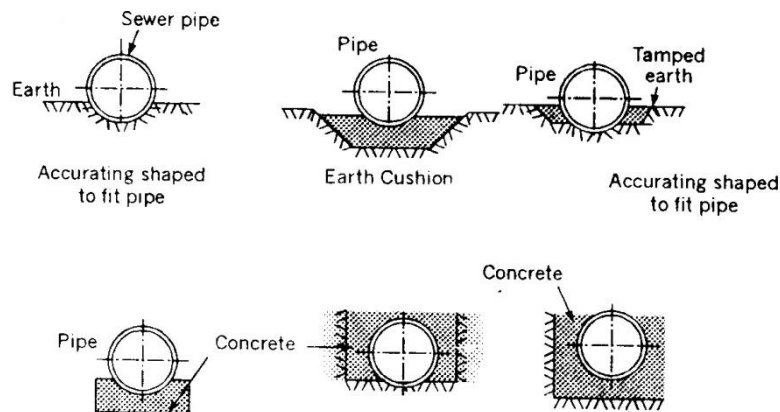

### Various types of pipe bedding

Figure 12.9

The centre line of sewers and their grades are transferred from the ground by means of sight rail and boning rod as shown in figure 12.10 by the following method:

- (i) Four stout stakes are driven into the ground or fixed over the pillars.
- (ii) Horizontal boards called sight rail are fixed on the stakes spanning the trench.
- (iii) The centre line of sewer is marked on the sight rail and nails are fixed on the sight rails at the position of centre line.
- (iv) The top of the nail or sight rail is fixed at some fixed distance from the invert level of the sewer at that spot. The line joining the top of nails fixed on the sight rails also confirm to the grade of the sewer.
- (v) Sight rails are usually fixed at 7.5 m centre to centre spacing and also at all junctions and change of gradient or alignment.

- (vi) Now a strong wire is stretched between the nails fixed on sight rails. This line is parallel to the grade of the sewer and also lies in the vertical plane passing through the centre line of the sewer.
- (vii) Now with the help of boning rod using plumb bob the line and grade to the sewer line is given as shown in figure 12.10.

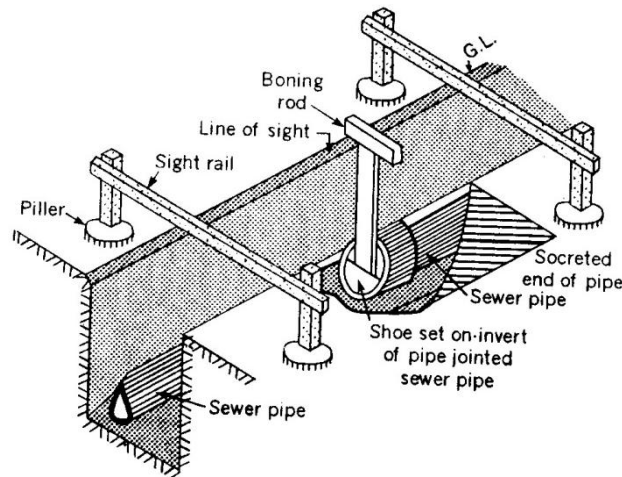

### Laying of sewer pipe

Figure 12.10

Smaller size pipes can be laid by the pipe-layers directly by hand only, but heavier and larger size pipes are lowered in the trenches by passing ropes around them and supporting through a hook.

#### Jointing of sewers:-

- (i) **Stoneware pipes:** - All the pipe joints shall be caulked with tarred gasket in one length for each joint and sufficiently long to entirely surround the spigot end of the pipe. This gasket shall be caulked lightly but not so as to occupy more than a quarter of the socket depth. The gasket shall then be filled with a mixture of one part of cement and one part of clean fine sand mixed with just sufficient quantity of water to have a consistency of semi-dry condition and a fillet shall be formed round the joint with a trowel forming an angle of  $45^\circ$  with the barrel of the pipe.
- (ii) **Concrete pipes:** - The collars shall be placed symmetrically over the end of two pipe and the annual space between the inside of the collar and the outside of the pipe shall be filled with cement slurry tamped with just sufficient quantity of water to have a consistency of semi-dry condition, well packed and



thoroughly rammed with caulking tools and then filled with cement mortar 1:2. The joints shall be finished off with a fillet sloping at 45° to the surface of the pipe. The finished joints shall be protected and cured for at least 24 hours. Any plastic solution or cement mortar that may have squeezed in the pipe shall be removed to leave the inside of the pipe perfectly clean.

- (iii) **Cast Iron pipes:** - The C.I pipes shall be examined for line and level and the space left in the socket shall be filled in by pouring molten pig lead. This shall be done by using proper leading ring. One or two air vents shall be provided around the lower end of the joint. The lead used shall be soft and of best quality.

**(5) Hydraulic testing of sewer pipes:**

Following two tests are generally done for testing the sewer pipes:

- (i) **Water test:** - Each section of the sewer is tested for water tightness preferably between manholes. The sewers are tested after giving sufficient time for the joints to set for no leakage. For this sewer pipe sections are tested between the manholes to manhole under a test pressure of about 1.5 m water head. To carry this, the downstream end of the sewer is plugged and water is filled in the manhole at upper end. The depth of water in manhole is maintained at about 1.5 m. The sewer line is inspected and the joints which leak are repaired.
- (ii) **Test for straightness of alignment:** - This can be tested by placing a mirror at one end of the sewer line and a lamp at the other end. If the pipe line is straight, full circle of light will be observed.

**(6) Backfilling of trenches:**

- (a) After testing and removing defects of pipe line, the trenches are back filled with earth. Generally the excavated soil of trench is used for back-filling but before using it, the pebbles, stone pieces and lumps must be removed from it.
- (b) The back filling is not done at a time. First the back filling is done by ramming the soil in layers, using water for proper consolidation. When the height of the back filled rammed soil reaches 60 cm above the crown of the pipe, the back-filling is stopped for at least one week for weathering.

- (c) After a week, again the back filling is started in layers and the trench is filled 15 cm above the ground level. During the course of time back-filled soil gets compacted and the filled soil comes to the ground level.
- (d) The back-filling is not done immediately after construction of the sewer lines. It is done after 7 days for precast pipes and after 14 days in case of cast-in-situ after casting the sewer. Tamping should be done carefully when doing it near the crown of the sewer.

**(7) Ventilation of sewers: -**

The sewers are to be properly and satisfactorily ventilated for the following two reasons:

- (i) **Continuous flow:** The surface of sewage should remain in contact with free air; otherwise air-lock will be formed.
- (ii) **Disposal of sewer gases:** The decomposition of sewage inside the sewers develops gases which are known as the sewer gases. These gases are harmful in many ways and hence they should be carefully disposed off in the atmosphere. The sewer gases include ammonia, carbon monoxide, carbon dioxide, methane, nitrogen etc. The gases like methane are highly explosive and if sewer is not properly ventilated, the manhole covers may be blown off. Similarly the gases being light in weight have a tendency to move upwards. They also interfere with the natural flow of sewage and cause air pollution when they escape into atmosphere.

Methods of ventilation: Following six methods are adopted for the ventilation of sewer:

- (a) **Manholes with chemicals:** - In this method, the chemicals are placed in the manhole covers. These chemicals react with the sewer gases and make them harmless. As this method is costly, it is rarely adopted.
- (b) **Manholes with gratings:** - In this method manhole covers are provided with gratings or openings through which sewer gases escape. This is a simple method. But it causes air pollution and hence it is adopted for isolated places where air pollution does not cause public nuisance. The other disadvantage of this method is that it permits road dust, storm water etc. to enter the sewer.

- (c) **Proper construction of sewers:** - The sewer should be laid at such a gradient that self cleansing velocity is developed and the sewage will have no chance of staying at one point for a longer period.
- (d) **Proper design of sewer:** - The sewers are designed to run two-third or even one half full and the remaining top space is reserved for the accumulation of sewer gases. The proper design of sewer ensures enough ventilation of sewers.
- (e) **Proper house drainage system:** - the lateral sewers are ventilated independently by suitable provision of ventilating shafts or columns. The sewer gases are carried in these columns and they are relieved in atmosphere above the height of the building.
- (f) **Ventilating columns or shafts:** - the ventilating columns or shafts are formed by joining cast-iron or steel pipes. They are placed at a distance of about 60 m or 150 m along the sewer line. A foundation block is provided at the bottom end of shaft to keep it in vertical position. A cowl is provided at the top end of shaft to allow the escape of sewer gases.

Figure 12.11 shows a typical vertical column used for the ventilation of sewer.

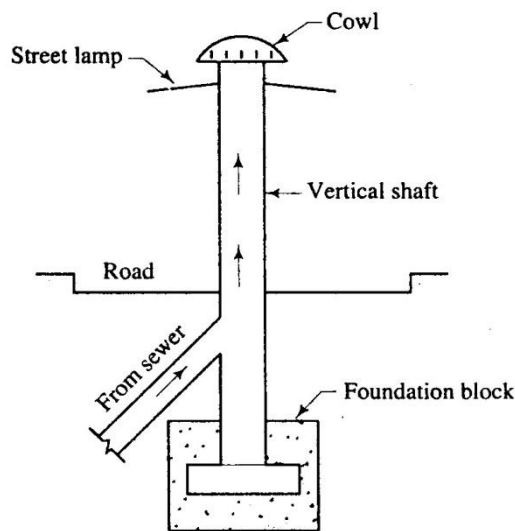

**Ventilating Column**

**Figure 12.11**

Following points should be kept in mind when this method of ventilation of sewers is adopted:

- (i) The internal diameter of the ventilating column should be preferably one-third of the diameter of the sewer which is being served by it.

- (ii) The joints of pipes forming the ventilating column should be made airtight. If the joints are not airtight, there will be leakage of sewer gases and it will result in unpleasant odours causing nuisance in the surrounding area.
- (iii) The location of ventilating columns should be such that they obtain sunshine for the major portion of the day. The heat of sunshine causes proper circulation of air.
- (iv) The top of ventilating column should be covered with wire mesh or cowl so as to prevent the birds from building their nests at the top of ventilating columns.
- (v) The ventilating columns should be carried higher than the height of nearby structures.

**(8) Cleaning and maintenance of sewers:**

The sewers should be properly cleaned and maintained in good working condition. The sewers which are once laid and buried into the ground should not be forgotten as they are also liable to corrosion, deterioration and erosion etc.

**Causes:** There are three important causes which make it necessary to clean the sewers

- (i) Breakage of sewers: - The sewers are sometimes broken after being laid under the ground. Several factors may contribute to the breakage of sewers, the important ones being poor foundation, excessive superimposed loads, impact due to vibrations etc.
- (ii) Clogging: - The clogging mainly occurs in sewer of small size as it is not possible for a man to enter into such sewer and clean them. The clogging may be due to waste building materials, deposition of sand and grit etc. Clogging is predominant in sewers laid at flat slopes in which self cleansing velocity are not developed.
- (iii) Odours: - The organic matter present in sewer decomposes and gives out unpleasant odour.

**Methods:**

Following are the most commonly adopted five methods which are employed for the cleaning and maintenance of sewers:

- (1) Cleaning and flushing
- (2) Cleaning of catch pits
- (3) Inspection
- (4) Periodical repairs
- (5) Proper connection

**(1) Cleaning and flushing:**

- The cleaning of large sewers is done manually. The man enters the sewer through manholes and scraps the sides of sewer by hand. The scraped material is removed through manholes.
- The cleaning of small sewers is effected by flushing. For this purpose, the automatic flushing tanks are sometimes installed on the sewer line.

When flushing is inadequate to remove obstructions in the sewer, the following methods are employed to make the sewer clean and unobstructed:

- (a) **Flexible rod:** - A flexible rod about 30 m in length is taken and inserted into the sewer. It is then pushed back and forth. The movement of rod dislocates the obstructions and it becomes easy to remove them by flushing.
- (b) **Mechanical tools:** - In this method, special cleaning tools are attached to the front portion of the rod and the cleaning of sewer is then carried out by moving the rod backward and forward. The tools may be double-worm screw, drain brush, wire brush etc.
- (c) **Use of pills:** - This is an interesting method of cleaning the sewer. In this method, the small pills or balls made of wood or hollow metal or rubber covered with canvas are used. A small pill is put in the manhole above the obstruction. The pill floats in the sewage and when it comes near the obstruction, it is caught there and the sewage starts collecting behind it. When sufficient head is developed the accumulated sewage removes the obstruction and the pill is caught in the next manhole. Then a pill of slightly larger diameter than the previous one is taken and the process is repeated until a pill having diameter about 25 mm less than that of sewer passes easily from one manhole to the other.

**(2) Cleaning of catch pits:**

- The catch pits used to collect storm water are cleaned after every storm. The catch pits contain debris, slit, sand etc. and even the water contained in catch pits is likely to give rise to the growth of mosquitoes.
- The oil and grease traps are also periodically cleaned to avoid the nuisance due to unpleasant odours.

**(3) Inspection:**

- The sewer and its appurtenances should be inspected at regular intervals to ascertain their proper working.
- The examination includes examination of structures, measuring rate of flow, determining the amount of clogging etc.
- In case of small sewers the free flow of sewage between adjacent manholes indicates that the sewer length is not clogged.

**(4) Periodical repairs:**

- The damaged portions of sewers should be immediately repaired. The brick sewers require frequent repairs. The broken bricks should be replaced and pointing to the brickwork should be done at regular intervals.
- The damaged or broken covers of street inlet or catch basin should be replaced.
- The manhole covers which have become loose by traffic should be tightened.
- The defective connections between house sewers and the street sewers should be immediately repaired.

**(5) Proper connection:**

- The connection of lateral sewer with branch sewer should be carried out by skilled plumbers. The plumbing work of house drainage should be carefully done and the joints should be made watertight.

## CHAPTER-13

### SEWER APPURTENANCES

**Definition:**

The structures, which are constructed at suitable intervals along the sewerage system to help its efficient operation and maintenance, are called as sewer appurtenances. These include:

1. Manholes
2. Drop manholes
3. Lamp holes
4. Clean-outs
5. Street inlets called Gullies
6. Catch basins
7. Flushing Tanks
8. Grease & Oil traps
9. Inverted Siphons
10. Storm Regulators

**(1) Manholes: -**

- The manhole is masonry or R.C.C. chamber constructed at suitable intervals along the sewer lines, for providing access into them. Thus, the manhole helps in inspection, cleaning and maintenance of sewer.
- These are provided at every bend, junction, change of gradient or change of diameter of the sewer.
- The sewer line between the two manholes is laid straight with even gradient.
- For straight sewer line manholes are provided at regular interval depending upon diameter of the sewer. The spacing of manhole is recommended in IS 1742-1960.
- For sewer up to 0.3 m diameter or sewers which cannot be entered for cleaning or inspection the maximum spacing between the manholes recommended is 30 m, and 300m spacing for pipe greater than 2.0 m diameter (Table 8.1).
- A spacing allowance of 100 m per 1 m diameter of sewer is a general rule in case of very large sewers (CPHEEO, 1993). The internal dimensions required for the manholes are provided in Table 8.2 (CPHEEO, 1993).

- The minimum width of the manhole should not be less than internal diameter of the sewer pipe plus 150 mm benching on both the sides.

Spacing of Manholes:

Pipe Diameter	Spacing
Small sewers	45 m
0.9 to 1.5 m	90 to 150 m
1.5 to 2.0 m	150 to 200 m
Greater than 2.0 m	300 m

The minimum internal dimensions for manhole chambers:

Depth of sewer	Internal dimensions
0.9 m or less depth	0.90 m x 0.80 m
For depth between 0.9 m and 2.5 m	1.20 m x 0.90 m, 1.2 m dia. for circular
For depth above 2.5 m and up to 9.0 m	For circular chamber 1.5 m dia
For depth above 9.0 m and up to 14.0 m	For circular chamber 1.8 m dia

**Classification of manhole:**

Depending upon the depth the manholes can be classified as:

- (a) Shallow Manholes, (b) Normal Manholes, and (c) Deep Manholes

(a) **Shallow Manhole:** -

- These are 0.7 to 0.9 m depth, constructed at the start of the branch sewer or at a place not subjected to heavy traffic conditions.
- These are provided with light cover at top and called inspection chamber.

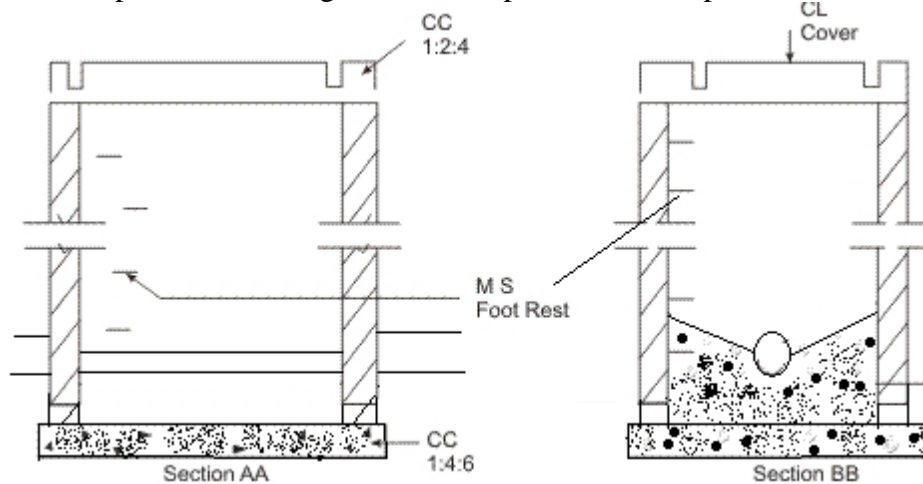

**Shallow Manhole**

**Figure 13.1**



(b) **Normal Manhole:** -

These manholes are 1.5 m deep with dimensions 1.0 m x 1.0 m square or rectangular 1.2 m x 0.9 m (Figure 13.2). These are provided with heavy cover at its top to support the anticipated traffic load.

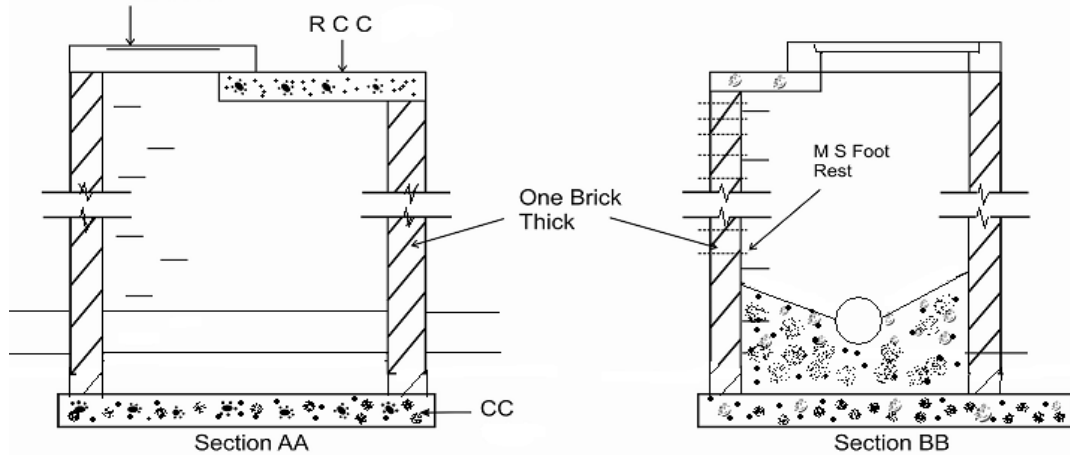

**Rectangular Manhole for depth 0.9 m to 2.5 m**

**Figure 13.2**

(c) **Deep Manhole:** -

The depth of these manholes is more than 1.5 m. The section of such manhole is not uniform throughout (Figure 13.3). The size in upper portion is reduced by providing an offset. Steps are provided in such manholes for descending into the manhole. These are provided with heavy cover at its top to support the traffic load.

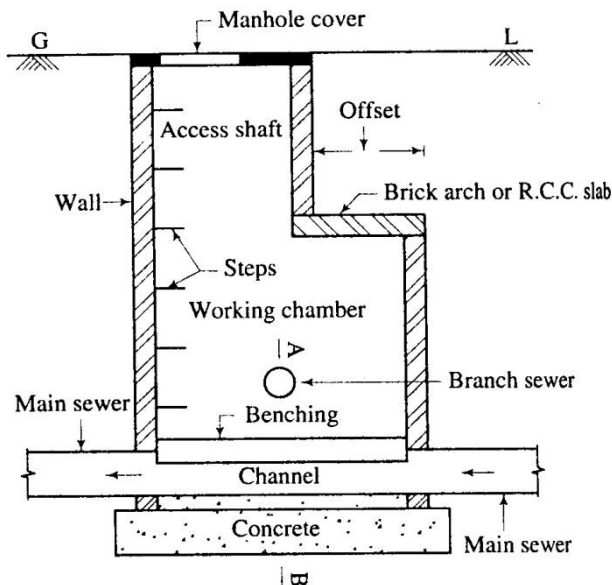

**Deep manhole**

**Figure 13.3**

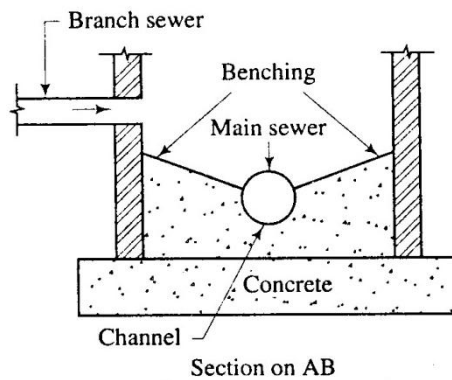

**Bottom of manhole**

**Figure 13.4**

**Component parts:**

A typical manhole consists of the following six parts:

- Access shaft
- Bottom or invert
- Cover with frame
- Steps or ladder
- Walls
- Working chamber

**Access shaft:** - The upper portion of a deep manhole is known as an access shaft and for rectangular manhole. Its minimum size should be about 750 mm x 600 mm. For circular manhole the minimum diameter should be about 600 mm to 750 mm. Its depth depends on the depth of manhole and the required for working chamber.

**Bottom or Invert:** - The bottom of manhole is constructed of cement concrete or brick paving. A semi-circular or U-shaped main channel is constructed and the sides are made to slope towards it. It is known as the benching and it facilitates the entry of sewage into the main channel. If sewers meet at the same level in the bottom of manhole, the channels connected with each other will have to be constructed.

**Covers with frame:** - The manhole is provided with cover and frame at its top. The cover and frame both are of cast iron. The depth of frame is about 200 mm to 250 mm and its base is about 100 mm wide. It is firmly embedded in the pavement and the cover rests in the groove which is kept inside the frame.

The weight of cover and frame varies from 90 kg to 270 kg. The light type is adopted to carry light traffic and the heavy type is adopted to carry heavy traffic.

The shape of manhole cover may be rectangular or circular, the latter being very common. The size of the former is about 600 mm x 450 mm and of the latter, it is about 500 mm to 600 mm diameter. The circular covers are stronger than rectangular ones and have the advantage that the cover cannot drop into the manhole.

The top surface of manhole covers is made rough by suitable designs. The smooth surface is objectionable as it is slippery.

The top of manhole covers should be properly adjusted in relation to the road surface. They should not form a source of inconvenience for traffic using road.

**Steps or ladder: -**

In order to make the entry and exit of man easy, the steps are provided in the manhole. The steps are made of cast-iron and they are placed staggered at a horizontal centre to centre distance of about 200 mm and at a vertical centre to centre distance of about 300 mm.

If depth of manhole is more, it is desirable to provide a ladder instead of steps. The ladder or steps should start from about 400 mm from ground or road level and should be continued up to about 300 mm height from bottom level of manhole.

**Walls: -** The walls of a manhole may be made of brickwork or stonework or cement concrete. The brick walls are very common and the minimum thickness of wall should be 200 mm.

**Working chamber: -** The lower portion of a deep manhole is known as working chamber and it provides a working space to carry out cleaning and inspection of sewer line. The minimum size of rectangular working chamber should be about 900 mm x 1200 mm and that of circular working chamber should be about 1200 mm diameter. The height of the working chamber should preferably be not less than 1800 mm or so.

**Other types of Manhole:**

**Straight-Through Manhole:**

- This is the simplest type of manhole, which is built on a straight run of sewer with no side junctions.
- Where there is change in the size of sewer, the soffit or crown level of the two sewers should be the same, except where special conditions require otherwise.

### **Junction Manhole:**

- This type of manholes are constructed at every junction of two or more sewers, and on the curved portion of the sewers, with curved portion situated within the manhole.
- This type of manholes can be constructed with the shape other than rectangular to suit the curve requirement and achieve economy.
- The soffit of the smaller sewer at junction should not be lower than that of the larger sewer.
- The gradient of the smaller sewer may be made steeper from the previous manhole to reduce the difference of invert at the point of junction to a convenient amount.

### **Side entrance Manholes:**

- In large sewers where it is difficult to obtain direct vertical access to the sewer from the top ground level due to obstructions such as, other pipe lines like water, gas, etc., the access shaft should be constructed in the nearest convenient position off the line of sewer, and connected to the manhole chamber by a lateral passage.
- The floor of the side entrance passage which should fall at about 1 in 30 towards the sewer should enter the chamber not lower than the soffit level of the sewer.
- In large sewers necessary steps or a ladder (with safety chain or removable handrail) should be provided to reach the benching from the side entrance above the soffit.

### **Drop Manholes:**

- When a sewer connects with another sewer, where the difference in level between invert level of branch sewer and water line in the main sewer at maximum discharge is greater than 0.6 m, a manhole may be built either with vertical or nearly vertical drop pipe from higher sewer to the lower one (Figure 13.5).
- The drop manhole is also required in the same sewer line in sloping ground, when drop more than 0.6 m is required to control the gradient and to satisfy the maximum velocity i.e., non-scouring velocity.
- The drop pipe may be outside the shaft and encased in concrete or supported on brackets inside the shaft.
- If the drop pipe is outside the shaft, a continuation of the sewer should be built through the shaft wall to form a rodding and inspection eye, provided with half blank flange (Figure 13.5).

- When the drop pipe is inside the shaft, it should be of cast iron and provided with adequate arrangements for rodding and with water cushion of 150 mm depth at the end. The diameter of the drop pipe should be at least equal to incoming pipe.

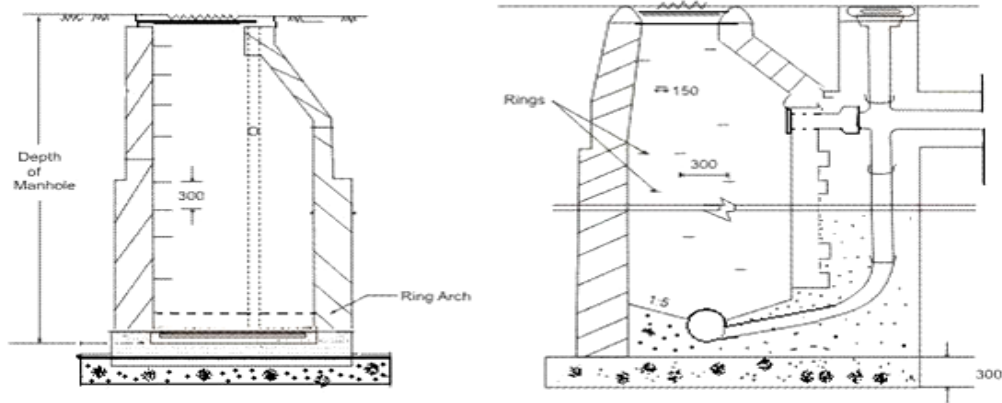

## Drop Manholes

Figure 13.5

### Flushing Manholes: -

- In flat ground for branch sewers, when it is not possible to obtain self cleansing velocity at all flows, due to very little flow, it is necessary to incorporate flushing device.
- This is achieved by making grooves at intervals of 45 to 50 m in the main drains in which wooden planks are inserted and water is allowed to head up.
- When the planks are removed, the water will rush with high velocity facilitating cleaning of the sewers.
- Alternatively, flushing can be carried out by using water from overhead water tank through pipes and flushing hydrants or through fire hydrants or tankers and hose.
- Flushing manholes are provided at the head of the sewers.
- Sufficient velocity shall be imparted in the sewer to wash away the deposited solids.
- In case of heavy chocking in sewers, care should be exercised to ensure that there is no possibility of back flow of sewage into the water supply mains.

### (2) Lamp hole: -

**Definition: -** A lamp hole is an opening or hole constructed in a sewer for the purpose of lowering a lamp inside it.

**Description:** - The lamp hole consists of vertical stoneware or concrete pipes which are connected to the sewer line through a tee – junction as shown in figure 13.6. The pipes are surrounded by concrete to make them stable. At the ground level, the manhole cover with frame is provided to take up the load of traffic.

**Objects:** - A lamp hole is installed in a sewer length to achieve the following three objects:

- Inspection: The lamp hole assists in examining the sewer length between adjacent manholes. An electric lamp is inserted in the lamp hole and the light of lamp is observed from the manholes.
- Flushing: Under some circumstances the lamp hole may be also used as the flushing devices.
- Ventilation: If the cover at the top of lamp hole is perforated, the ventilation of sewer is achieved.

**Location:** - Following are the places where the lamp holes are to be located:

- If construction of a manhole is difficult, a lamp hole may be constructed in its place.
- A lamp hole proves to be economical when change in direction or gradient is to be made between two adjacent and closely spaced manholes.
- When the sewer length is straight for a considerable distance beyond the usual spacing between manholes, the provision of a lamp hole is advisable.

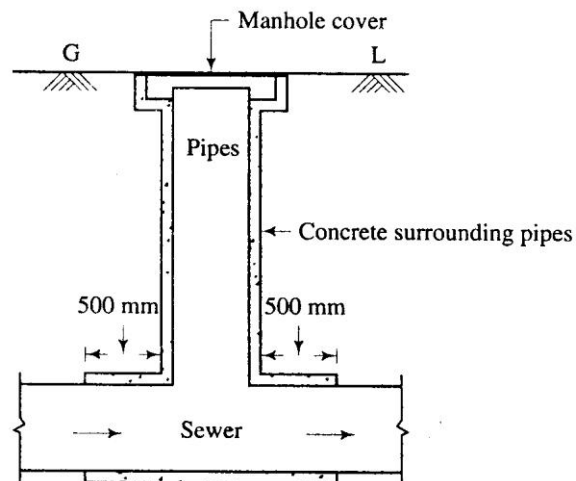

**Lamp Hole**

**Figure 13.6**

**(3) Clean-outs: -**

- It is a pipe which is connected to the underground sewer. The other end of the clean-out pipe is brought up to ground level and a cover is placed at ground level (Figure 13.7).
- A clean-out is generally provided at the upper end of lateral sewers in place of manholes.
- During blockage of pipe, the cover is taken out and water is forced through the clean-out pipe to lateral sewers to remove obstacles in the sewer line.
- For large obstacles, flexible rod may be inserted through the clean-out pipe and moved forward and backward to remove such obstacle.

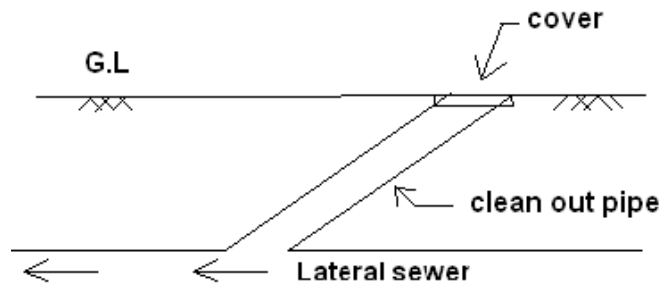

**Clean-out**

**Figure 13.7**

**(4) Street inlets called Gullies: -**

**Definition:** An inlet is an opening through which storm water and surface wash flowing along the streets are admitted conveyed to the storm water sewer or combined sewer by means of pipes.

**Location:** The inlets are located or placed by the sides of roads at a distance of about 30 m to 60 m. The inlets are so located that storm water is collected in a short period and there is no flooding or accumulation of huge quantity of storm water on the roads.

**Types:** These are classified in three major groups viz. curb inlets, gutter inlets, and combined inlets.

**Curb Inlet: -**

- These are vertical opening in the road curbs through which storm water flow enters the storm water drains. These are preferred where heavy traffic is anticipated.

**Gutter Inlet: -**

- These are horizontal openings in the gutter which is covered by one or more grating through which storm water is admitted.

**Combined Inlets: -**

- In this, the curb and gutter inlet both are provided to act as a single unit. The gutter inlet is normally placed right in front of the curb inlets.

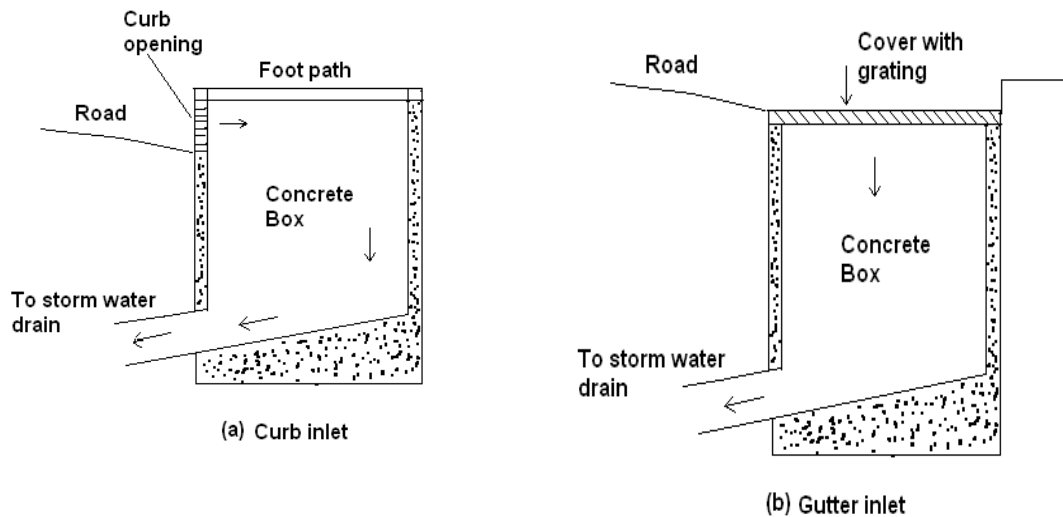

Figure 13.8

**(5) Catch basins or catch pits:**

- Catch basins are provided to stop the entry of heavy debris present in the storm water into the sewers.
- However, their use is discouraged because of the nuisance due to mosquito breeding apart from posing substantial maintenance problems.
- At the bottom of the basin space is provided for the accumulation of impurities.
- Perforated cover is provided at the top of the basin to admit rain water into the basin. A hood is provided to prevent escape of sewer gas.



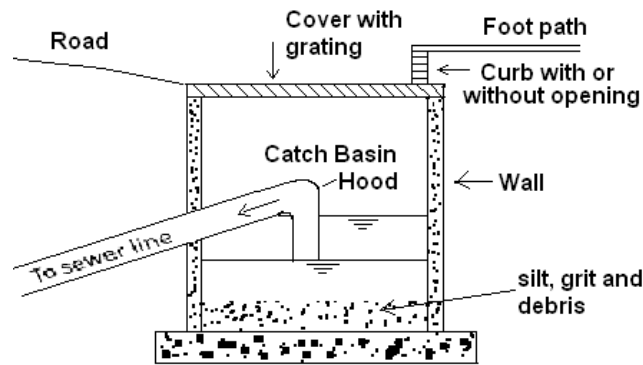
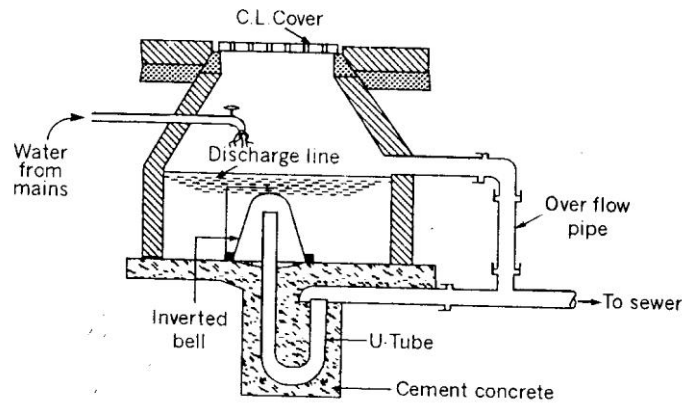

Figure 13.9

- The catch basin provides a temporary storage of impurities contained in rain water. Hence it demands periodical cleaning. Otherwise the organic matter decomposes and gives out bad smell.

#### (6) Flushing Tanks: -

- When the gradients of the sewers are flat and the velocity of sewage is very low, the suspended matter of sewage start settling in the bed of sewer and causes clogging of sewer lines.
- At such places where self cleansing velocity is not available, flushing tanks are provided to flush the sewers.
- These tanks are usually provided at the beginning point of the sewer and may be either automatic or worked by hand. Automatic flushing tanks are most commonly used.
- In manually operated flushing arrangement water or sewage is held up in the sewer by plugging the inlet and outlet ends of the sewer. When the flushing tank is filled up with water by tap, the outlet plug is removed; all the water rushes towards the outlet and flushes the sewer.
- In automatic flushing tank the water is automatically released from the tank at required interval, which can be adjusted by the supply pipe tap and flushes the sewer.
- An automatic flushing tank is shown in figure 13.10. It consists of a masonry or concrete chamber fitted with a tap for filling the tank with water. A U-tube with a bell cap at its one end connects the chamber with sewer. When the water level increases in the chamber, it also increases in the bell cap. As soon as it reaches a certain level, siphonic action takes place and the whole water of the chamber rushes to the sewer pipe and flushes it.
- The capacity of these tanks is usually 900-1400 litres and it is adjusted in such a way as to work twice or thrice a day depending on the quantity of deposits in the sewer and size of sewer.



**Automatic Flushing Tank**

**Figure 13.10**

**(7) Grease and oil trap:**

- The sewage from hotels, restaurants, kitchen and industries contain grease, oils and fats, which if not removed before it enters the sewers, will stick to the interior surface of the sewer conduit and will become hard and cause obstruction in the movement of the sewage.
- To check them grease traps are required which are placed in the pipe connecting the kitchen with sewer line.
- Sewage from garages and service stations contains sand, mud, oils and grease which should also be removed before the sewage enters the sewer line.

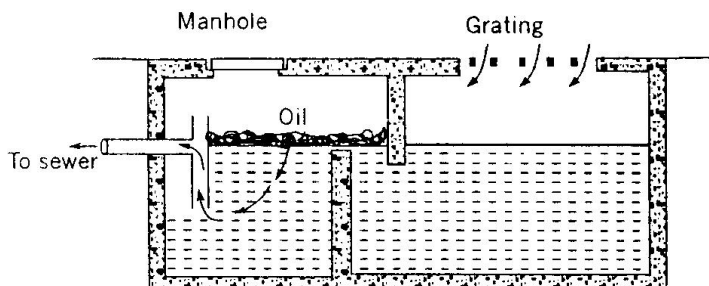

**Combined silt and oil trap**

**Figure 13.11**

**(8) Inverted siphon:**

- During laying of sewer in a town, at some places, the hydraulic gradient line falls above the ground surface.
- If there is more depression in the ground and the area is undeveloped or cultivated, sewer line can be laid above the ground by supporting on piers. But sewer cannot be laid above the ground at such places where road, canal and railway line cross the sewer line.
- To overcome such an obstruction in sewer lines, inverted siphons are provided.
- In an inverted siphon the hydraulic gradient line the hydraulic gradient line is above the flow line, whereas in true siphon the hydraulic line is below the flow line.
- Inverted siphons are also known as depressed sewers, because the sewer portion at such portion is below the general sewer line.
- Figure 13.12 shows the plan and sectional elevation of an inverted siphon.
- The pipe of inverted siphon must be able to withstand the internal pressure.
- The pipe diameter should be such that the sewage may flow with a great velocity to avoid silting.
- The inverted siphons are generally constructed of cast iron or R.C.C.
- At the ends of the inverted siphon manholes are provided for inspection and cleaning purposes. Both inlet and outlet should be given such a slope that the sewage can easily flow.
- The outlet chambers should be so designed as to prevent the back-flow of sewage into pipes which are not being used at the time of minimum flow.

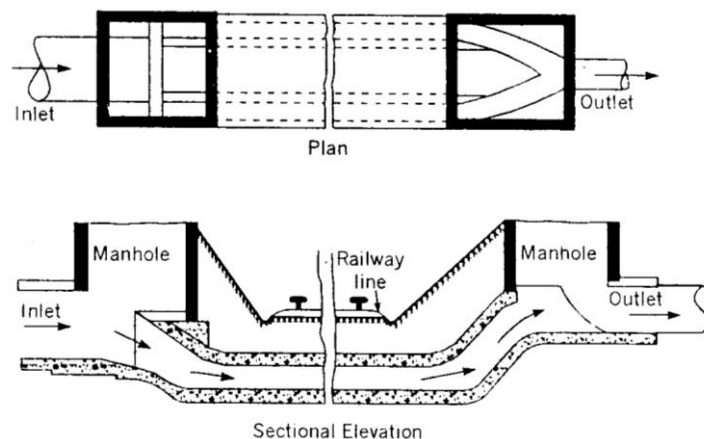

**Inverted Syphon**

**Figure 13.12**

**(9) Storm regulator:**

These are used for preventing overloading of sewers, pumping stations, treatment plants or disposal arrangement, by diverting the excess flow to relief sewer. The overflow device may be side flow or leaping weirs according to the position of the weir, siphon spillways or float actuated gates and valves.

**(a) Side flow weir:**

- It is constructed along one or both sides of the combined sewer and delivers the excess flow during storm period to relief sewers or natural drainage courses (Figure 13.13).
- The crest of the weir is set at an elevation corresponding to the desired depth of flow in the sewer.
- The weir length must be sufficient long for effective regulation of the flow.

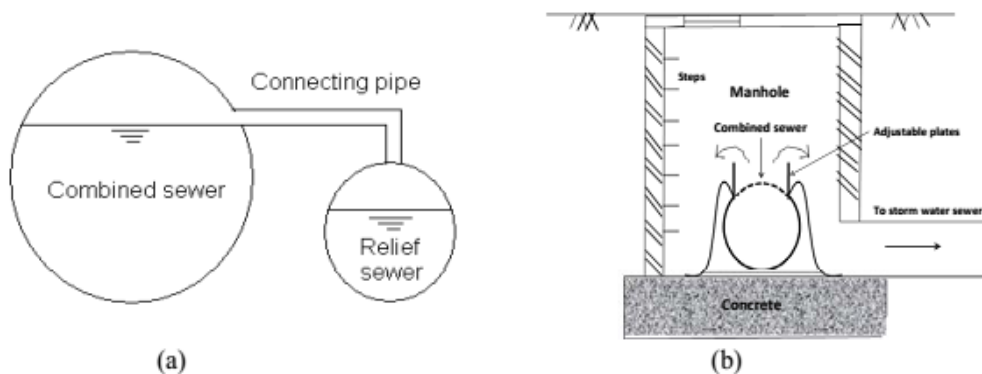

**(a)Side flow weir (b) Overflow weir arrangement**

**Figure 13.13**

**(b) Leaping weir:**

- The term leaping weir is used to indicate the gap or opening in the invert of a combined sewer.
- The leaping weir is formed by a gap in the invert of a sewer through which the dry weather flow falls and over which a portion of the entire storm leaps.
- This has an advantage of operating as regulator without involving moving parts.

- However, the disadvantage of this weir is that, the grit material gets concentrated in the lower flow channel.
- From practical consideration, it is desirable to have moving crests to make the opening adjustable.
- When discharge is small, the sewage falls directly into the intercepting sewer through the opening. But when the discharge exceeds a certain limit, the excess sewage leaps or jumps across the weir and it is carried to natural stream or river.

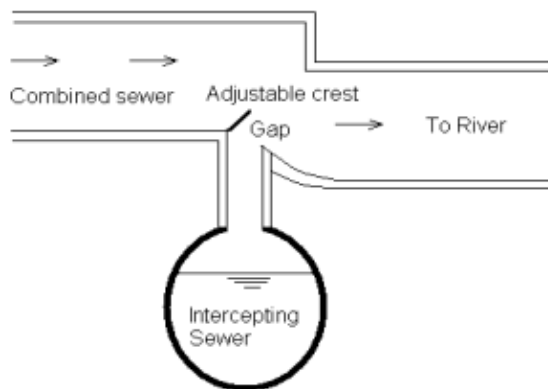

**Leaping weir with adjustable crest**

**Figure 13.14**

**(c) Float actuated gates and valves:**

- The excess flow in the sewer can also be regulated by means of automatic mechanical regulators.
- These are actuated by the float according to the water level in the sump interconnected to the sewers.
- Since, moving part is involved in this, regular maintenance of this regulator is essential.

**(d) Siphon spillway:**

- This arrangement of diverting excess sewage from the combined sewer is most effective because it works on the principle of siphon action and it operates automatically.
- The overflow channel is connected to the combined sewer through the siphon.

- An air pipe is provided at the crest level of siphon to activate the siphon when water will reach in the combined sewer at stipulated level (Figure 13.15).

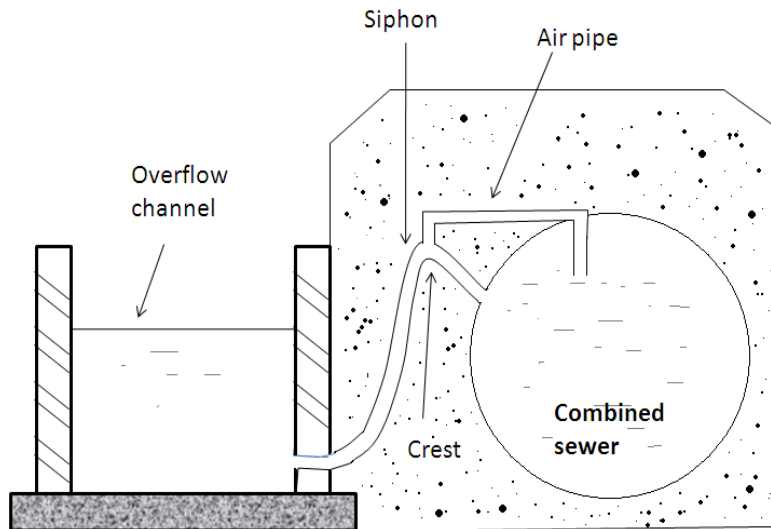

**Siphon spillway**

**Figure 13.15**

**Sewage Pumping: -**

In sewerage system at some places the sewage cannot flow under its gravitational force only and it requires it's lifting. Under following circumstances it becomes necessary to pump the sewage:

- If some portion of the town is low laying and the sewage cannot flow by gravity into mains and sub-mains, the entire sewerage system in that area is laid at the required low level and the sewage is pumped from lower branch up to the main sewer line.
- When basements are provided in the building the sewage is pumped to the sewer line.
- When the land is flat and it is not possible to get self cleansing velocity, the sewer are laid at required slope and after some interval they are allowed to flow under gravity.
- At treatment plant to rise it upto the plant for treatment.
- At the outfall while disposing it of it is required to be pumped if the level of the water course is higher than the outlet of the sewer.

**Capacity of pumping stations:**

- The capacity of pumping station is determined by the present and future sewage flows based on a designed period of 15 years.
- Care should be taken regarding future expansion, such as provision of additional space for replacing the smaller pumping unit by larger ones, thus increasing the capacity of the wet well and constructing new pumping stations to cope with the increased sewage flow.

**Types of pumping stations:**

- Pumping stations are provided with two separate wells one is wet well for receiving the incoming sewage and dry wells for installing the pump.
- The wet well and dry well may be any of the following:
  - (1) Circular with central dry well and peripheral wet well.
  - (2) Rectangular with dry and wet wells adjacent to each other.
  - (3) Circular with a dividing wall to separate the dry and wet well.

**Location of pumping stations:**

- The following points should be considered while locating the site of pumping stations:
  - (1) The topographical conditions of the city should be thoroughly studied to locate the best site of pumping station.
  - (2) If the quantity of sewage is very large, the site should be near the point of disposal.
  - (3) The site should be such that during flood it should not be flooded with river water.
  - (4) Provision should be made to pump all the sewage which will be received during worst condition of rain.

**Requirement of sewage pumps:**

- It can pump the sewage upto required elevation.
- It should be reliable.
- It should be cheap in initial cost and maintenance.
- It should not be corroded by the organic and inorganic waste of sewage.
- It should not be damaged by the presence of sand, gravel and stone etc. present in the sewage.
- It should require less space for installation.
- It should not make more noise during working.

**Classification of pump:**

Sewage pumps can be classified as

- (a) Centrifugal pump
- (b) Reciprocating pump
- (c) Pneumatic Ejector
- (d) Air Lift Pumps

**(a) Centrifugal Pumps:**

- These pumps work on the principle of centrifugal force.
- They essentially consists of two main parts (1) the casing and (2) the impeller.
- The impeller of the pump rotates at high speed inside the casing.
- Sewage is drawn through the suction pipe into the pump where curved rotating vanes throw it up through the outlet pipe.
- The clearance between the vanes of the impeller is sufficient to allow any solid matter entering the pump to pass out in the outlet.
- These pumps are very simple in working and construction can be installed in small pits and sumps.
- Centrifugal pumps are not obstructed by the presence of sand, gravel, mud in the sewage.
- The open impeller type centrifugal pumps are more suited because solids and other fibrous materials can be easily pumped by open types.
- The centrifugal pumps are classified on the basis of their speeds (Ns) at the point of maximum efficiency.
- The specific speed of an impeller is defined as the speed, in revolutions per minute at which a geometrically similar impeller would run if it were of such size to deliver 1m<sup>3</sup>/min against 1.0 m head.
- The specific speed is given by the equation:

$$N_s = 3.65n/QH^{0.75}$$

Where Q = flow in m<sup>3</sup>/min

H = head in metre

N = speed in rpm

The centrifugal pumps can be classified as follows:



- (1) **Axial flow pumps:** These pumps develop most of their head by the propelling action of the impeller vanes on the liquid. They are characterised by a single inlet impeller with the flow entering axially and are usually used for capacity more than 2000m<sup>3</sup>/hr and head less than 9 meter. These pumps are of vertical type. The axial flow pumps have relatively high specific speed from 8000-16000. The vertical pumps have positive submergence of the impeller for their proper operation.
- (2) **Mixed flow pumps:** These pumps develop head developed partly by centrifugal action and partly by the lift of the impeller vane on the liquid. These pumps have single inlet impeller with the flow entering axially and discharging in an axial and radial direction, usually into a volute type casing. These pumps are used for medium heads of 8m to 15 m and for medium to large capacities. The specific speeds of these pumps are from 4200 to 9000. These pumps require positive submergence, but can also be used for limited suction lift.
- (3) **Radial flow centrifugal pumps:** These pumps consist of two parts: (1) the casing and (2) the impeller. The impeller of the pump rotates at high speed inside the casing. Sewage is drawn from the suction pipe into the pump and curved rotating vanes throw it up through outlet pipe because of centrifugal force. Radial-flow pumps throw the liquid entering the centre of the impeller out into a spiral volute or casing. The impellers of all centrifugal pumps can be closed, semi open, or open depending on the application. Open impeller type pumps are more suitable because suspended solids and floating matter present in the sewage can be easily pumped without clogging. These pumps can have a horizontal or vertical design. These pumps are commonly used for any capacity and head. These pumps have low specific speed up to 4200.
- (4) **Reciprocating Pumps:** These pumps are not suitable for sewage pumping because solids and fibrous material clog them, even after passing the sewage through screens. These are high initial cost, difficult in maintenance, have low efficiency and cause much wear and tear of valves, therefore not used in sewage pumping.
- (5) **Pneumatic Ejectors:**
  - Centrifugal pumps are suitable for pumping large quantity of sewage. These are not suitable for pumping small quantity of sewage, because the pumps required in such cases are of very small size, which will often remain clogged. At such places the pneumatic ejectors are most suitable.

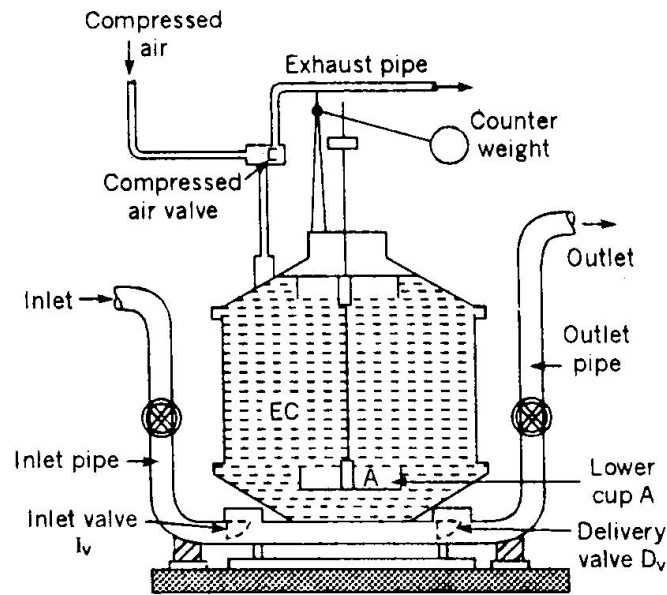

### Pneumatic Ejector

Figure 13.16

- Figure 13.16 shows the section through Shone's Ejector which is mostly used in sewage system. It works on compressed air, which can be supplied from the central station. The working is as follows:
- Sewage enters through the inlet pipe by gravity and after opening the inlet valve  $I_v$ , it rises in the ejector chamber EC.
- During this operation the delivery valve  $D_v$  remains closed and the air from chamber EC escape out through the exhaust pipe by opening exhaust valve.
- The rising sewage also lift with it the lower cup A, which is connected to the compressed air valve by means of a set of levers.
- When the cup A is lifted up to a certain level, it operates the lever opening the compressed air valve.
- As the compressed air valve is opened the compressed air enters the chamber EC and pushes the sewage up through the delivery pipe after opening the delivery valve  $D_v$ .
- When the level of sewage drops in EC, the cup A also drops and closes the compressed air valve. This cycle is continued and the sewage is lifted.
- Following are the main advantage of Pneumatic Ejector:
  - (a) As the sewage is completely enclosed, no sewer gases can escape except through the vent shaft.

- (b) The operation of the ejector is fully automatic.
- (c) Very little attention and lubrication of part is required, because only a few parts are in direct contact of the sewage.
- (d) There is less chance of clogging.

**(6) Air lift Pump:**

- These pumps work on compressed air and have no moving parts, therefore are most suitable for sewage pumping.
- These are simple in operation and give least trouble because they have no remote or submerged moving parts.
- It consists of a vertical pipe known as educator pipe placed inside the wet well.
- Air inlet pipe is lowered in the educator pipe with the direction of its outlet upwards as shown in figure 13.17.

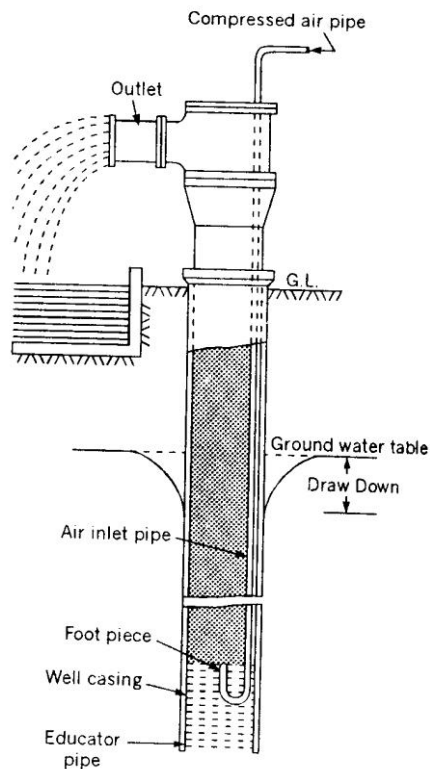

**Air lift pump**

**Figure 13.17**

- Top end of the air inlet pipe is connected to the air compressor.
- The compressed air is released through the air diffuser connected at the lower end of the air inlet pipe in the educator pipe.
- This air is mixed with the sewage and forms bubble having low specific gravity than that of sewage.
- In the beginning the level of sewage inside and outside of the educator pipe is same but when compressed air is passed the density of sewage inside the educator pipe is reduced due to which mixture of sewage rises in the educator pipe.
- These pumps have very low efficiency and can lift the sewage up to small height only.

**Elements pumping stations:**

Pumping station consists of the following:

- (1) Preliminary screening and grit chamber
- (2) Sump or wet well
- (3) Pump room or dry well
- (4) Pump with driving engine or motor
- (5) Miscellaneous accessories such as pipes, valves, fittings, flow recorder, emergency over flow etc.

**(1) Preliminary screening and grit chamber:**

- The sewage reaching the pumping station contains large amount of sand, gravel, paper, leaves etc.
- Before the sewage is pumped it is necessary to remove all these things to prevent the wear and tear of the machinery.
- Large floating materials are removed by passing through screens.
- After passing through screen it goes into grit channel where inorganic solid matters are removed.

**(2) Wet well:**

- The sewage from the city is received at pumping station in a tank known as sump or wet well.
- The capacity of wet well is such that it can store D.W.F of at least 2 hours, which is the maximum period during which pumps can be repaired or replaced.

- The sump well is an underground masonry or R.C.C chamber, placed at such a level that sewage from the trunk sewer can flow into it by gravity only.
- The tank may be rectangular or circular in shape in the plan. Mostly circular wet wells are used, the bottom of which is given a 1:1 slope towards a central pit where the end of suction pipe of the pump is placed.
- The depth of well depends upon the depth of incoming sewage inlet.
- Guide pipes filled with flats, switches of motors, cables of electric motor, sewage level indicator etc should be installed in the wet well at suitable places.
- Gate valve should be fitted on the incoming sewer line to stop the sewage flow during inspection, repair and cleaning of the wet well.
- In the top of the wet well manholes with ladder are provided for its cleaning, maintenance and inspection.
- The over flow weirs and by-pass arrangements are also provided in the wet well for diverting the sewage during emergency floods.

**(3) Pump room or dry well:**

- It is placed in convenient place and pumps are installed inside it. Its location should be such so that pumps can easily function.
- This is an underground masonry or R.C.C structure having circular or rectangular shape in the plan.
- The sewage pump, their driving units, control valves and necessary pipes with the fittings are installed in it.
- The size of the dry well should be sufficient for the movement of the operator during operation, maintenance and repair as well as installation of pumps etc.
- The size of the dry well should be sufficient to accommodate installation of more pumps for the future expansion with the design period.
- Sometimes in small sewage pumping station no separate dry well is provided.
- It is better to take deep these wells, so that pumps may not require any priming during starting.
- The pumps may be submerged in the wet wells or may be provided on the roof of the wet well.

**(4) Pipes, valves, fittings etc.:**

- The cast iron pipes with flanged joints should be provided in all the installation works at the pumping station. It provides easiness in dismantling and repair of the equipments.
- The size of the pipes should be designed in such a way that sewage can flow at the velocity of 0.6 to 0.9 m/sec inside them. The velocity will prevent the settlement of the solids present in the sewage.
- The length of the discharge pipe should be kept as small as possible, because long detention of sewage in closed pipes under pressure causes their anaerobic deterioration.
- To reduce the loss in head number of valves, bends, junction etc should be kept as small as possible.
- Check valve should be provided in the sewer line discharging the sewer, to prevent the back flow of sewage during floods in the rivers or discharge area. The location of the check valve should be on the horizontal section of sewer to prevent any possible settlement of the suspended solids.
- Gate valves should be provided on the sewer line just before the wet well and on the suction and discharge pipe to close the floe of sewage during maintenance, inspection and repair of the pumps.
- Pressure gauge to note the suction pressure and discharge pressure should be installed at the appropriate position to record the suction and delivery pressures.
- Sewage level indicator should also be filled in the wet well to record the level of the sewage.

**(5) Pump with driving engine or motor:**

- **Location of driving units:** following points should be kept in view while deciding the location of driving units:
- They should be close to the pumps.
- They should be provided away from the damp or hot surroundings. It should not be provided in the wet well or at such places where it may come in contact of corrosive or explosive gases, as the gases may be exploded due to short – circuiting and the damp climate may burn the motor.

- **Power of the driving unit:**
- The power of the driving units to be installed on the sewage pumping station depends on the following:
- The maximum total head under which pumping is to be done including loss of heads.
- The maximum pumping rate or discharge of pumping.
- The efficiency of the pumps.
- The efficiency of the driving unit.
- The loss of head due to friction is determined by the following formula:

$$H_f = 4flv^2/2gd$$

The B.H.P of the driving unit is directly calculated by the following formula:

$$\text{B.H.P} = wQH/75n_p n_m$$

Where  $Q$  = Discharge

$H$  = water head

$n_p$  = efficiency of the pump

$n_m$  = efficiency of the driving engine of motor

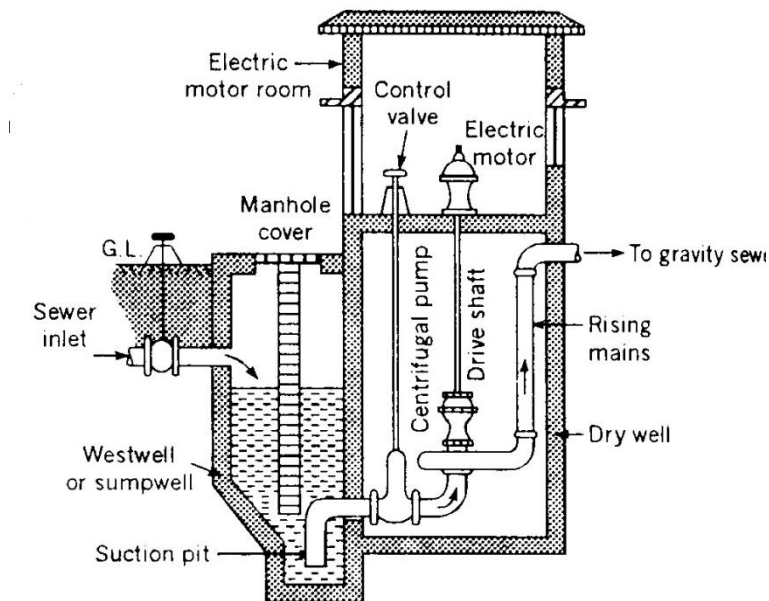

Section through a pumping station

Figure 13.18

## CHAPTER-14

# Sewage characteristics

### General importance :-

Sewage is dilute mixture of the various types of wastes from the residential, public and industrial places. The characteristics and composition of sewage mainly depend on this source. Sewage contains organic and inorganic matters which may be in dissolved, suspension and colloidal state. Sewage also contains various types of bacteria's, virus, protozoa, algae, fungi etc. Some of these are pathogens and are harmful to the human and animal life.

### Strength of sewage:-

Sewage is a water-carried waste, in solution or suspension, which is intended to be removed from a community. Also known as wastewater, it is more than 99% water and is characterized by volume or rate of flow, physical condition, chemical constituents and the bacteriological organisms that it contains.

### Characteristics of sewage:-

The characteristics of sewage can be classified as

- i) Physical characteristics
- ii) Chemical characteristics
- iii) Biological characteristics
- iv) Physical characteristics:-

The sewage has the following **(i) physical characteristics:**

#### **(a) Colour & Odour-**

Fresh domestic sewage has a slightly soapy and cloudy appearance depending upon its concentration. As time passes the sewage becomes stale, darkening in colour with a pronounced smell due to microbial activity.

#### **(b)Temperature:-**

The observations of temperature of sewage are useful in indicating solubility of oxygen, which affects transfer capacity of aeration equipment in aerobic systems, and rate of biological activity. Extremely low temperature affects adversely on the efficiency of



biological treatment systems and on efficiency of sedimentation. In general, under Indian condition the temperature of the raw sewage was observed to be between 15 to 35<sup>0</sup>C at various places in different seasons.

**(c) Turbidity:-**

The turbidity of the sewage directly depends on the quantity of the solid matter present in it in suspension state.

**(d) Solids:**

Though sewage contains only about 0.1 percent solids, the rest being water, still the nuisance caused by the solids cannot be overlooked, as these solids are highly putrescible and therefore need proper disposal. The sewage solids may be classified into dissolved solids, suspended solids and volatile suspended solids. Knowledge of the volatile or organic fraction of solid, which decomposes, becomes necessary, as this constitutes the load on biological treatment units or oxygen resources of a stream when sewage is disposed of by dilution? The estimation of suspended solids, both organic and inorganic, gives a general picture of the load on sedimentation and grit removal system during sewage treatment. Dissolved inorganic fraction is to be considered when sewage is used for land irrigation or any other reuse is planned.

**(ii) Chemical characteristics:-**

SEWAGE contains complex organic matters derived from urine, faeces etc and organic chemicals. The organic compounds can be divided as containing nitrogen and free from nitrogen .urea, proteins, amines and amino acids are nitrogenous compounds. The salts and alkalies as inorganic matters are also present in sewage, which come from bathrooms, kitchens and industrial plants.

**(iii) Biological characteristics:-**

Sewage contains large quantity of bacteria which come from excremental matter. All the bacteria present in sewage are not harmful. more quantity is of harmless bacteria, which help to treat the sewage and reduce the cost of treatment plants only pathogenic bacteria which are discharged by the sick persons having infections diseases such as cholera, typhoid, dysentery, diarrhea etc are to harmful to the human and give difficulties at the treatment plants.

Following are the main living organism in sewage:

- **Bacteria:-**

The disease causing bacteria are known as pathogens and come under the category of lower bacteria. The pathogens in sewage from the of sick people having infectious disease the pathogens may cause typhoid, fever, paratyphoid fever, bacillary dysentery and cholera. The bacteria are very sensitive in their environments and if they are kept in different circumstances not suiting them, they die or their growth stopped.

- **Algae:-**

The algae are unicellular plants containing chlorophyll and often additional pigments on which these have various names the presence of pigments enable the algae to utilize the radiant energy. the physiological process involved is called photosynthesis and helps algae in absorbing carbon dioxide and releasing oxygen.,

- **Fungi:-**

The cells of fungi do not contain chlorophyll and pigments. These are usually colourless and are filamentous having branches. The yeasts, bacteria and molds come under the group of fungi. The size of mold flora usually present in sewage is large. They have the property of decomposing starches sugars, cellulose, fats, proteins, higher alcohols and nitrogen substances.

- **Protozoa:-**

These include all the unicellular animals. There are various types of protozoa such as amoeboid, flagellae and ciliate protozoa, amoeboid protozoa are irregular in shape, naked or shekked, single or colloinal. They move by means of false feet. Mostly all the protozoa are bacteria eaters and destroy the pathogens.

## **Analysis of sewage:**

The number of determinations to be made depends upon the purpose for which the analysis is to be used and the source of the sample of sewage, effluent, polluted water or industrial waste.

There are different tests are for analysis of sewage. They are:-

### **Sampling tests for solids:**

### **pH Testing Procedures**

- pH is defined as the negative logarithm of the hydrogen ion concentration. pH is a convenient way of expressing a very small number. The pH scale ranges from 0 to 14 with 7 being neutral. pH values of less than 7 are considered acid, or acidic, while values greater than 7 are considered basic or alkaline.
- pH greatly affects biological activity. Extremes of pH may injure or kill many bacteria and even cause a halt to all biological activity. Most bacteria perform best at pHs between 6.5 to 8.0.
- pH also affects digester performance, sludge dewatering, chemical treatment, and disinfection processes.
- In the laboratory, pH is determined using a pH meter. The meter is standardized by using 2 buffer solutions approximately 4 units apart which will bracket the pH of the sample. Buffers are specially prepared solutions which resist any pH change. They are available commercially at practically any pH value either as a liquid ready to use or as a dry powder needing dilution with distilled water.
- To buffers are used to standardize a pH meter to be certain the meter is working correctly. In measuring pH, only a grab sample should be used and the analysis must be performed immediately. If at all possible, the analysis should be done on site.

### **Dissolved Oxygen Testing Procedures**

- The dissolved oxygen analysis measure the amount of gaseous oxygen dissolved in water or wastewater. Oxygen is a necessary element in all forms of life. Oxygen dissolved in wastewater encourages the growth of aerobic bacteria. Adequate dissolved oxygen is needed to allow natural stream purification processes to proceed and provide for aerobic life forms in the receiving water.
- All other things being equal, the amount of oxygen that can dissolve in pure water (the saturation point) is inversely proportional to the temperature of the water. In other words, the lower the temperature of the water, the higher the dissolved oxygen level will be at saturation. Conversely, the higher the temperature of the water, the lower the dissolved oxygen level will be at saturation. This is particularly important during warm weather periods when the stream biological activity will be highest but the dissolved oxygen saturation level will be lowest.

- There are several laboratory methods to determine dissolved oxygen content. The most commonly used analysis is a wet chemistry method referred to as the Winkler Method. The Winkler Method test involves the use of several chemical reagents and a titration procedure. The normality of the titrant used must be known exactly for accurate determination. Since a sodium thiosulfate solution is normally used, this becomes a particularly important point as the normality of thiosulfate solutions continually decrease with age. To overcome this problem it is necessary to determine the normality of thiosulfate solution daily or before each testing period.
- A more stable titrant may be used for the Winkler determination of DO which negates the need for daily standardization of the reagent. The most common titrant substitute is phenylarsene oxide (PAO). PAO solutions need only be standardized when initially prepared.

### **Biochemical Oxygen Demand (BOD)**

Biochemical Oxygen Demand, BOD, as it is commonly abbreviated, is one of the most important and useful parameters (measured characteristics) indicating the organic strength of a wastewater. BOD measurement permits an estimate of the waste strength in terms of the amount of dissolved oxygen required to break down the wastewater. The specifics of the analysis are discussed in detail in *Standard Methods for the Examination of Water and Wastewater*. The BOD test is one of the most basic tests used in the wastewater field. It is essentially a measure of the biological and the chemical component of the waste in terms of the dissolved oxygen needed by the natural aerobic biological systems in the wastewater to break down the waste under defined conditions. Generally the BOD test is carried out by determining the dissolved oxygen on the wastewater or a diluted mixture at the beginning of the test period, incubating the wastewater mixture at 20°C, and determining the dissolved oxygen at the end of 5 days. The difference in dissolved oxygen between the initial measurement and the fifth day measurement represents the biochemical oxygen demand.

- While BOD describes the biological oxidation capacity of a wastewater, it is not a measure of the total potential oxidation of the organic compounds present in the wastewater. A number of chemical tests are used to measure this parameter, either in terms of the oxygen required for virtually complete oxidation, or in terms of the element carbon. Probably the most common test for estimating industrial wastewater strength is the Chemical Oxygen Demand (COD) Test. This test essentially measures the chemical oxidation of the wastewater by a strong oxidizing agent in an acid solution. The value for the COD test is always greater than the BOD test and is not always a good indication of BOD values for the same waste.
- A test which measures carbon and which is being used to a greater extent in measuring wastewater strength is the TOC (Total Organic Carbon) test where the carbon is oxidized by catalytic combustion to carbon dioxide and the carbon dioxide is measured.
- The normality of any prepared solution should be checked when first received or prepared to insure proper strength as claimed. PAO solutions are stable over very long periods of time and are also extremely poisonous. Persons handling PAO should exercise great care to avoid ingesting the solution or its residues.
- If large numbers of DO determinations are to be performed routinely, a dissolved oxygen meter may be used. Standardization and operation procedures for DO meters will vary from manufacturer to manufacturer. It is suggested that the manufacturer's instructions be followed faithfully for correct and accurate operation of the meter.
- When performing DO analysis, only grab samples should be used and the analysis must be performed immediately

### **Chemical Oxygen Demand (COD) Testing Procedures**

The Chemical Oxygen Demand (COD) test measures the oxygen equivalent consumed by organic matter in a sample during strong chemical oxidation. The strong chemical oxidation conditions are provided by the reagents used in the analysis. Potassium dichromate is used as the oxygen source with concentrated sulfuric acid added to yield a strong acid medium. Several reagents are added during the set up of the analysis to drive the oxidation reaction to completion and also to remove any possible interference. Specifically, these reagents are

mercuric sulfate, silver sulfate and sulfamic acid. Mercuric sulfate is added to remove complex chloride ions present in the sample. Without the mercuric sulfate the chloride ions would form chlorine compounds in the strong acid media used in the procedure. These chlorine compounds would oxidize the organic matter in the sample, resulting in a COD value lower than the actual value. Silver sulfate is added as a catalyst for the oxidation of short, straight chain organics and alcohols. Again, without the silver sulfate the COD of the sample would be lower than the actual value. Sulfamic acid is added to remove interferences caused by nitrite ions. Without sulfamic acid the COD of the sample would measure higher than the actual value. Silver sulfate is added as a catalyst for the oxidation of short, straight chain organics and alcohols. Again, without the silver sulfate the COD of the sample would be lower than the actual value. Sulfamic acid is added to remove interferences caused by nitrite ions. Without sulfamic acid the COD of the sample would measure higher than the actual value.

Even with the use of these additional reagents the oxidation of the organic matter is not always 100% complete. Volatile organics, ammonia and aromatic hydrocarbon are not oxidized to any great degree during the procedure.

The advantages of the COD test as compared to the BOD test are:

1. COD results are available much sooner.
2. The COD test requires fewer manipulations of the sample.
3. The COD test oxidizes a wider range of chemical compounds.
4. It can be standardized more easily.

The major disadvantage of the COD test is that the results are not directly applicable to the 5-day BOD results without correlation studies over a long period of time. The samples used for the COD analysis may be grab or composite. Preservation of the sample can be accomplished by adding sulfuric acid to depress the pH to 2 and the holding time with preservation is 7 days.

- Significance of parameters:

### **B.O.D Test:**

- i) B.O.D is the principal test, which gives an idea of the biodegradability of any sample

and strength of the waste.

- ii) B.O.D is an important parameter in the design of treatment plant to determine the size of certain units particularly trickling filters and activated sludge units.
- iii) B.O.D is useful to estimate the population equivalent of any industrial wastes, which is useful to collect cess from industrialists for purification of industrial wastes in municipal sewage treatment plants.

### **C.O.D Test:**

- i) The C.O.D test is widely used in place of B.O.D test in the operation of treatment facilities because of its high speed of obtaining the results.
- ii) The C.O.D test is very useful to assess the strength of wastes which contains toxic and biologically resistant organic substances.
- iii) The ratio of B.O.D and C.O.D is useful to assess the amenability of waste for biological treatment.
- iv) The C.O.D. test is widely used in the analysis of the industrial wastes.

## **Sampling and Testing Procedures**

### **Sampling of Wastewaters**

The value of any laboratory result depends on the integrity of the sample. The object of sampling is to collect a portion of wastewater small enough in volume to be conveniently handled in the laboratory and still representative of the wastewater to be examined. It must be collected in such a manner that nothing is added or lost in the portion taken and no change occurs during the time between collection and laboratory examination. Unless these conditions are met, laboratory results may be misleading and worse than no results.

The location of sampling points and the collection of samples cannot be specified for all wastewater plants. Conditions vary in different plants and the sampling procedure must be adapted to each plant. Certain general principles can be listed.

1. The sample should be taken where the wastewater is well mixed. This is most easily accomplished if the sampling point is located where the wastewater flow is turbulent, for example, at a tap on the discharge side of a pump, where a free fall from a pipe line occurs, where the discharge from a pipe is against a baffle as at the inlet of a tank, or just as the flow enters a pipe as at the effluent line from a tank.
2. Large particles should be excluded. Large particles are all those greater than one-quarter inch in diameter. This is reasonable because if one large piece was included in a one-gallon sample, it would mean that wastewater would contain one million large pieces per million gallons of wastewater. Raw wastewater should be sampled after screening where screens or comminutors are used.
3. No deposits, growths or floating materials that have accumulated at the sampling point should be included. Obviously, such material would not be representative of the wastewater. This may be difficult if sampling is at a manhole, but it can be done if care is used.
4. Samples should be examined as soon as possible. If held for more than one hour, they should be cooled by immersion of the sample bottle in ice water. Bacterial decomposition of wastewater continues in the sample bottle. After one hour, the changes due to such decomposition are appreciable. Cooling the sample greatly retards bacterial action.
5. The collection of proper samples should be made as easy as possible. Sampling points should be readily accessible, proper equipment should be at hand, safety precautions established, and protection of personnel from inclement weather provided, for the easier it is to take proper samples, the more likely it will be done.
6. Sample preservation may be necessary for some chemical constituents. The accepted preservatives and the holding times for the various constituents are listed in EPA Manual "Methods for Chemical Analysis of Water and Wastes".



## CHAPTER-15

### SEWAGE DISPOSAL

The sewage begins to cause nuisance as it becomes stale. So the sewage need to be disposed off without treatment or after suitable treatment . Finally the sewage is disposed off either in natural water course or on land.

#### 15.1 DISPOSAL ON LAND :

##### SEWAGE FARMING

When the sewage is used for growing crops, it is called sewage farming. The nutrients of sewage like nitrogen, phosphorous and potassium along with micronutrients as well as organic matter are directly utilised by the plant. The sewage increases the fertility of the soil along with irrigation potential. The good sewage farm should run on scientific lines with primary objective of disposal of sewage , utilisation to the possible extent in a good sanitary manner without polluting the soil, open water courses or underground water or contamination of the crops or impairing the productivity of the farm and hygienic safety to the staff against the infection by pathogenic organisms. Under no circumstances raw sewage should be applied to the farms directly.

##### SEWAGE APPLICTION AND DOSING

The sewage can be applied to the land by the following methods.

#### 1. Surface Irrigation

The parallel drains are constructed in the fields. All drains are connected to a distributary drain by means of regulating device so that the sewage can flow in the required drain. This method is suitable in sloppy areas. The sewage is allowed to overflow through fields from one drain towards another.

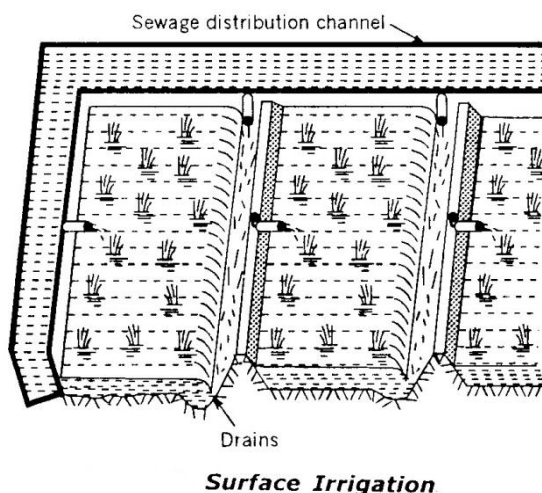

Fig.15.1

## 2. Subsoil irrigation

In this method a network of porous open joint pipes is laid about 30cm below the ground level. The sewage is allowed to flow through these pipes which is absorbed by the sub-soil. The remaining quantity of sewage, if any, can be used for irrigation to another place or discharged in natural water courses.

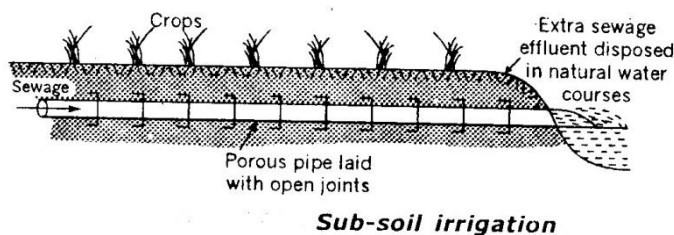

Fig.15.2

## 3. Flooding

The irrigation area is divided into various parts surrounded by dykes. The sewage is filled like small ponds in between the dykes as shown in fig. The depth of sewage flooded over the fields varies from few centimetres to 50cm depending on the requirement of the irrigation.

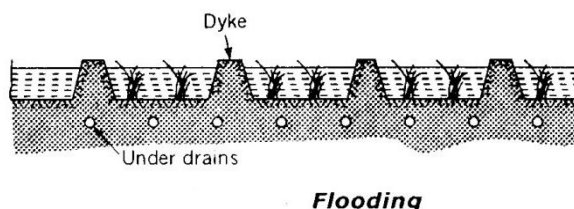
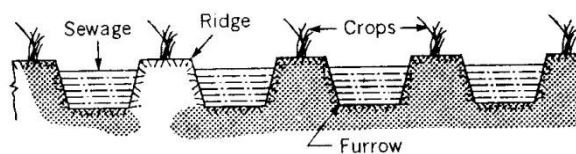

Fig.15.3

## 4. Ridge and furrow.

In this method the land is first ploughed deep up to 30cm levelled and divided into plots and subplots. Then each subplot is enclosed by small dykes. Now ridges and follows are formed in each subplot. The sewage is allowed to flow in furrows, where as crops are grown on ridge as shown in fig. After an interval of 8-10 days the sewage can be again applied depending on the crops requirement and the nature of the soil.



**Ridge and furrows.**

Fig.15.4

## 5. Spray irrigation

This method is not used in India . In this method , first the sewage is filled in tanks so that settleable solids may settle. Then the sewage is sprayed over the fields by pumping it through pipes fitted with nozzles at the other end.

## SEWAGE SICKNESS

When the sewage is continuously applied on the land, the pores of soil continuously go on decreasing and a stage comes when the soil gets clogged by the deposition of solids of sewage. After reaching this stage , the air cannot circulate through the soil pores, therefore anaerobic conditions cannot continue, resulting in the starting of anaerobic conditions. When anaerobic decompositions start, the hydrogen sulphide gas is produced creating nuisance in the area. In this condition the sewage treating capacity of the land is exhausted and it cannot accept any more load of sewage. When such stage is reached the land is said to be sick.

## REMEDIES

- By giving primary treatment to the sewage the suspended solids are removed, due to which the pores of the soil will not be clogged easily.
- By giving rest to the land i.e. intermittent application of sewage on land. The land should be ploughed thoroughly during the non-supply period so that the soil gets aerated.
- By planting different crops in the land in rotation, which will aerate the soil and utilise the fertilising elements of sewage.
- By providing under drainage system to collect the excessive quantity of sewage.
- By frequent ploughing and rotation of soil.

## 15.2. DISPOSAL BY DILUTION:

The disposal of sewage by discharging it into water courses such as streams, rivers or large body of water such as lake , sea is called **dilution**. This method is only possible when the natural water in required quantity is available near the town.

If the sewage is to be discharged in sea or tidal river water, the required standards for the polluted water are given in table 15.1 .

Class of	Standards of polluted sea or tidal river water	Use of polluted water
A	(i) Full removal of floating solids (ii) M.P.N. of B-coli 100/100ml. (iii) D.C. 50% of saturation value	For fish life development recreation and shell fish culture.
B	(i) Full removal of floating solids (ii) Minimum 10% removal of suspended solids (iii) D.O. 50% of saturation value (iv) M.P.N. of B-coli 100/100ml.	All other use except given in Class A
Class of	Standards of polluted water	Use of polluted water
A	B-coli < 50/100ml. Without filtration	For drinking purpose after chlorination
B	B-coli < 100/100ml. No visible sewage	For recreation, bathing and shell fish culture  For irrigation and rough industrial use etc.
C	D.O. > 3 to 5 p.p.m and CO <sub>2</sub> < 40	
D	No odour , nuisance and unsightly suspended floating matters. D.O should be present.	

### SELF-PURIFICATION OF STREAM

When sewage is discharged into natural waters, its organic matter gets oxidised by the dissolved oxygen content in water. The oxidation of organic matter converts such matter into simple inoffensive substance. The deficiency of dissolved oxygen thus created in natural waters is filled up by the absorption of atmospheric oxygen. Thus the oxygen of water is consumed by the sewage and at the same time , it is replenished by the atmosphere. This phenomena which occurs in all natural waters is known as the *self-purification* of natural waters.

The rate of self-purification will depend on various factors such as rate of re-aeration, type of organic matter present in sewage, temperature, velocity of flow, presence of available oxygen in receiving waters, sedimentation etc. The self-purification process of streams polluted by sewage can be grouped in following four zones.

**1. Degradation Zone**

This zone is situated just near the point of entering sewage into the stream. The water is turbid with dark colour. The decomposition of soil matters takes place in this zone and the anaerobic decomposition prevail.

**2. Active decomposition Zone**

In this zone the water is greyish and darker than the previous zone. The objectionable odours of hydrogen sulphide and other sulphur compounds prevail and scum may also be seen on the surface in this zone.

**3. Recovery zone**

In this zone the stabilization of organic matters takes place and the B.O.D of water is reduced. The contents of dissolved oxygen start rising up above 40% of the saturation value. The bacterial load decreases as the food supply of bacteria diminishes.

**4. Clear water Zone**

In this zone the stream attains normal conditions as were prevailing before sewage is discharged into it.

## CHAPTER-16

### SEWAGE TREATMENT

#### PRINCIPLES OF TREATMENT

Sewage contains various types of impurities and disease bacteria. This sewage is disposed of by dilution or on land after its collection and conveyance. If the sewage is directly disposed of, it will be acted upon the natural forces, which will convert it into harmless substances. The natural forces of purification cannot purify any amount sewage within specified time. If the quantity of sewage is more, then receiving water will become or the land will become sewage sick. Under such circumstances it becomes essential to do some treatment of sewage, so that it can be accepted by the land or receiving water without any objection.

Thus the main objective of the treatment units to reduce the sewage contents from the sewage and remove the entire nuisance in such a way that it can be safely discharged in the natural water course applied on the land.

#### FLOW DIAGRAM OF CONVENTIONAL TREATMENT

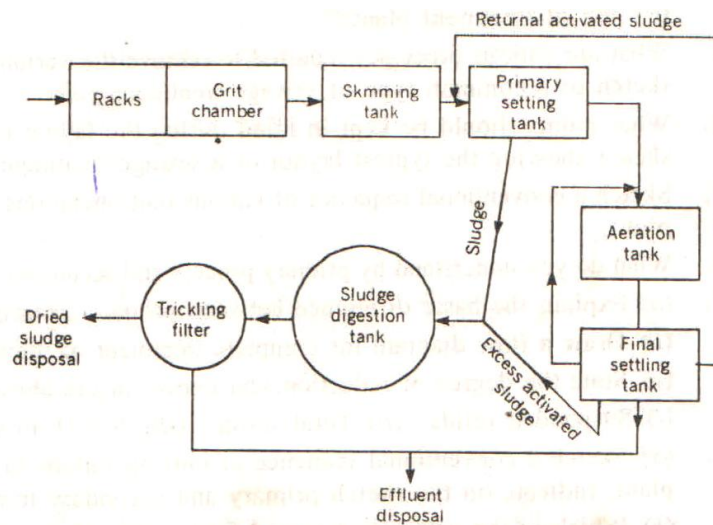

FIG.16.1

#### PRIMARY TREATMENT

The sewage contains various suspended, floating, and oily substances. By primary treatment these substances are removed from the sewage so that the working of the sedimentary treatment units may be easy and there are no disturbances in the operation of those units. The units of the primary treatments are as follows:

## SCREENS

The screen is the first unit of primary treatment plant. The function of screen is to remove all the floating debris like wood pieces, cloth and paper pieces, decayed fruits and vegetables etc. If these floating matters are not eliminated, it may choke the pipe lines or it may cause damage to the pumping unit.

**Construction:** The screens may be constructed of M.S bars or rods, gratings, wire meshes or perforated plates. The M.S. bar screen is made by placing parallel bars with spacings according to the following types.

**Coarse screen:** The spacing of bars is more than 40mm centre to centre.

**Medium screen:** The spacing of bars is less than 40mm.

**Fine screen:** The spacing of bars vary from 1.5mm to 6mm.

The screens may be fixed or movable. The inclination of the screen varies from  $30^\circ$  to  $60^\circ$ .

The screens are placed at designed inclination in an oblong rectangular chamber. The ends of the chamber are tapered. It is constructed with brick masonry. The inner surfaces are plastered and finished with neat cement polish. A perforated rectangular channel is provided at the top of the screen for collecting floating debris.

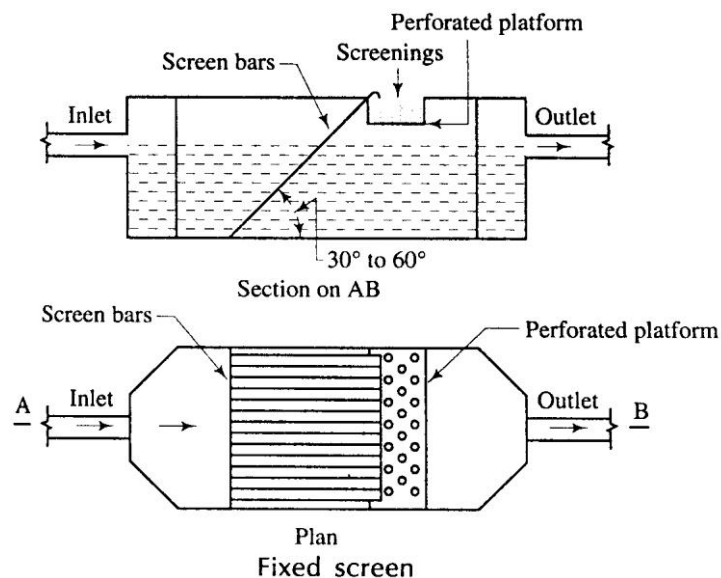

FIG.16.2

**Operation:** The raw sewage is allowed to enter the chamber through the inlet pipe. The floating debris are obstructed by the screen and collected near it. The sewage containing the other suspended materials passes through the screen and is taken to the next unit.

**Cleaning:** The debris may be cleaned by manual labours or mechanical device. In manual system, the debris are taken by rakers and collected in the perforated channel from where these are disposed of. In mechanical device system, a raking arm like crane is provided which collect the debris at regular interval and throws in a collecting basin from where these are disposed of.

### **Disposal**

**Dumping :** The debris are dumped in low-lying areas far away from the locality.

**Burning:** After drying the debris are burnt to ashes.

**Composting:** Good quality manure may be obtained by composting the debris in compost plant.

### **GRIT CHAMBER**

The function of grit chamber is to remove the inorganic substances like grit, sand and other suspended materials. The velocity of flow in the grit chamber is kept low so that a detention period is available for the settlement of the above substances.

**Construction** The grit chamber is an oblong rectangular chamber and constructed with brick masonry. As shown in fig the floor of the chamber is made sloping for the collection of grits at a particular zone. The inner surfaces are plastered and finished with neat cement polish. It consists of an agitator for agitating the deposited grit at the time of cleaning. A pipe line with valve is provided at the bottom of the chamber for periodical removal of the grits. The length, width and depth are designed according to the volume of sewage.



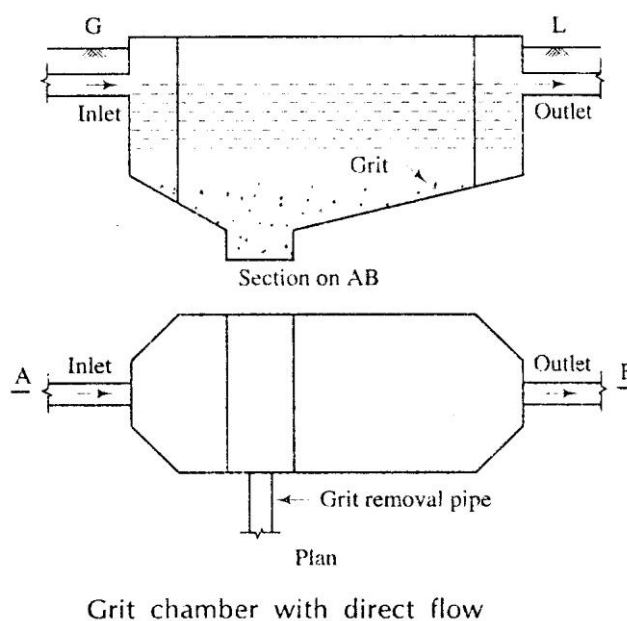

FIG.16.3

**Operation:** The sewage from the screen chamber is allowed to enter the grit chamber and flow at a low velocity of 20 cm to 30 cm per sec. Due to the low velocity; the grits, sands, etc are settled down at the bottom of the grit chamber.

**Cleaning:** At the time of cleaning, the deposited grits are agitated by agitator and the muddy water comes out through the removal pipe. The grits may also be cleared from top by manual labours with the help of buckets.

**Disposal** The grits are generally dumped in low-lying areas for the reclamation of land.

### PRIMARY SEDIMENTATION TANK

The function of primary sedimentation tank is to remove colloidal particles like silt and clay and some organic substance. Moreover it reduces the load on the secondary treatment. Coagulants may be used, if necessary.

**Construction:** It is a rectangular tank constructed with brick masonry. Baffle walls are provided in zigzag way so as to lengthen the path of the flow of the sewage. Inlet and outlet pipes are provided on opposite corners and these are provided with valves. A sludge removal pipe is provided at the bottom of the tank.

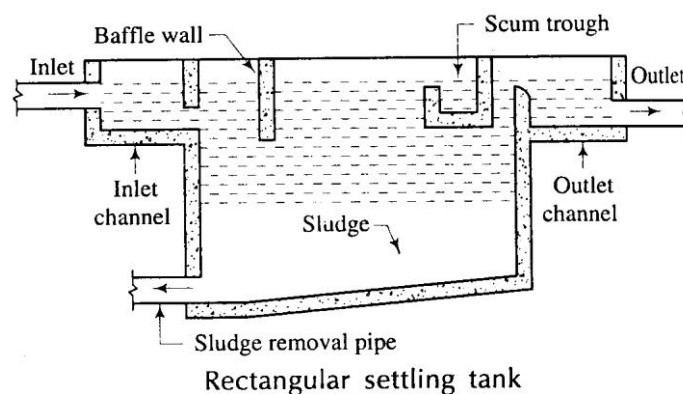

FIG.16.4

**Operation:** The sewage enters the tank through the inlet pipe and flows along the zigzag path and hence the velocity of flow is reduced. Thus the sewage is detained for a considerable period in the tank. The colloidal particles and organic substances are settled down at the bottom of the tank. The comparatively clear water passes out through the outlet pipe.

**Cleaning:** The sludge is cleaned periodically through the removal pipe by opening the valve.

**Disposal:** The sludge may be disposed of by pumping in ditches or low-lying areas or may be dried in sludge drying beds and can be used as manure.

### 16.3 SECONDARY TREATMENT

In the primary treatment, the larger solids in sewage are removed. But the effluent still contains organic matters, bacteria, colloidal matters etc. Such effluent cannot be discharged into the natural water course. So secondary treatments are given to the effluent of primary treatment to make it safe in all respects and suitable for discharging it into the river. The units of the secondary treatments are as follows:

#### CONTACT BED

Contact bed is a method of filtration of sewage. Its rate of filtration is low. In contact bed, the sewage is brought in contact with the filtering media for some specified period. During this period, a biological film is formed around the particles of the filter media and the bacterial colonies are formed in the film. These bacteria are responsible for the oxidation of organic matters. Again, when the bed is kept empty for some period, the filter gets oxygen from atmosphere and oxidizes the organic matters if they remain deoxidised.

**Construction:** It is a rectangular tank which is divided into several beds. The depth of bed varies from 1m to 2m. Each bed is filled up with filtering media of gravel, ballast or broken stones as shown in fig. The effective size of ballast varies from 15mm to 50mm. A siphonic

dosing tank is provided for the supply of sewage to all the bed simultaneously. Generally the rate of filtration is 500 litres per m<sup>3</sup> of filter media.

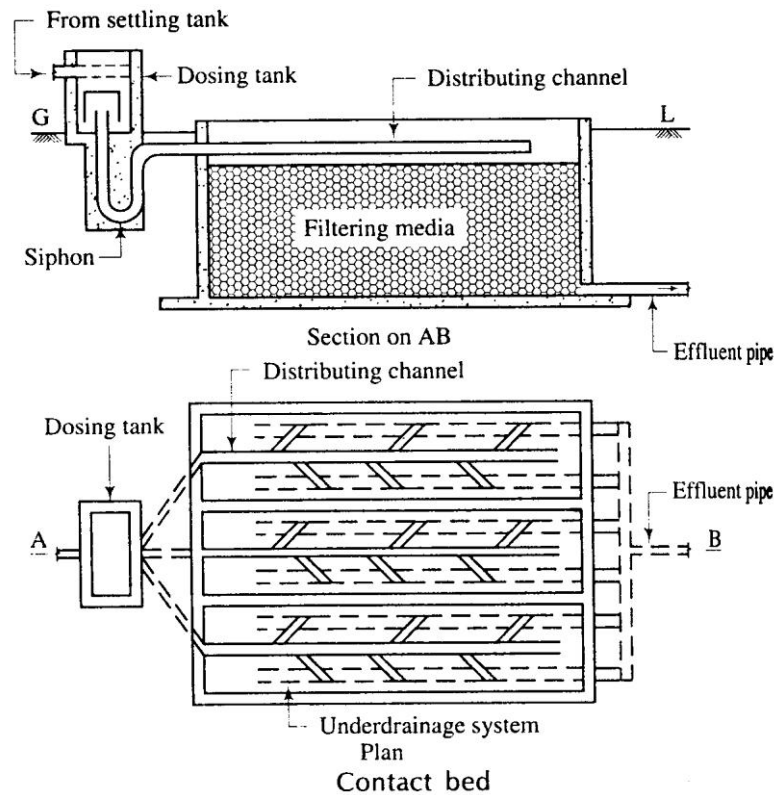

**FIG.16.5**

**Operation:** The bed is filled with sewage through the siphonic dosing tank and it may take about two hours. The sewage is allowed to stay in the filter media for about 2 hours. The effluent is allowed to flow through the effluent pipe for the disposal to natural water course. This may take about 2 hours. The bed is allowed to stay empty for about 4 hours. Thus, the cycle of operation continues during the working period.

### TRICKLING FILTER

Trickling filter is a method of filtration of sewage. The rate filtration is high as compared to contact bed. The principle of trickling filter is that the bacterial film which is formed around the filtering media is the source of formation of the bacterial colonies. These bacteria decompose the organic matters for their survival. So the trickling filter serves the purpose of breaking the complex organic matter by fertilising the bacteria.

### Elements of trickling filter

**Construction of filter:** Generally the trickling filter is circular in shape. It consists of 4 nos. of rotary distributing arms which have perforation at the bottom. The arms are fitted with a

central support which is rotated by a suitable device. The floor of the filter is made of concrete and its slope is made towards the periphery.

**Dosing of filter:** A siphonic dosing tank is provided with the trickling filter for intermittent supply of effluent over the filtering media.

**Filtering media:** It consists of broken stones, clinkers etc with their size varying from 20-50mm. The larger size stones are placed at the bottom layer and the smaller size stones are arranged towards the top. the stones or clinkers should of good quality.

**Under drainage system:** It consists of a channel along the periphery of the filter. The channel is again connected to the outlet pipe.

**Ventilation:** The ventilation of the filter is necessary for the smooth working of the filter. The ventilation is achieved by providing vent pipes at the periphery.

**Working:** The effluent is spread over the filtering media of broken stones by rotary arms. The effluent trickles down the media and gets collected in the channel. The channel carries the effluent to the outlet pipe through which the effluent is taken for chlorination.

**Cleaning:** After working for long period, the upper surface of the media may be clogged by sediments. The rate of filtration may be decreased or stopped due to this. At that time , the upper layer of stones are scrapped off and fresh layer of stones of same size are replaced properly.

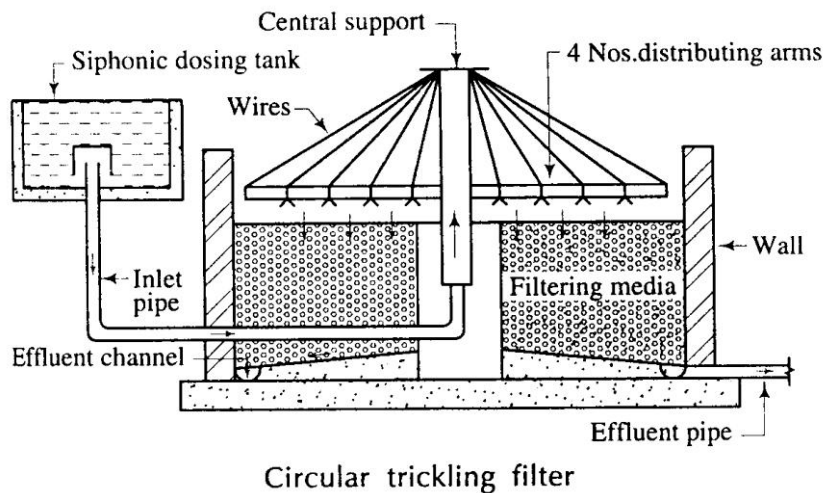

FIG.16.6

## ACTIVATED SLUDGE PROCESS

### Definition

The sludge which is made powerful by the process of aeration is known as activated sludge. It contains high content of oxygen and high no. of aerobic bacteria. It possesses unusual property to oxidise the organic matters.

### Action

The following are the actions of activated sludge:

- (i) The activated sludge when mixed with sewage, the microorganisms multiply rapidly.
- (ii) The activated sludge oxidises the organic substances rapidly.
- (iii) It converts the colloidal matters to settleable size rapidly.

Operational features

1. **Mixing of activated sludge** : Some portion of the activated sludge settled at the bottom of secondary settling tank is recirculated and mixed with the effluent of primary settling tank just before its entry to the aeration tank.
2. **Aeration**: Aeration tank is the first unit of the activated sludge process. Here, the effluent of the primary settling tank and air are brought in intimate contact by agitating with some mechanical devices. The devices are as follows:
  - a) Air diffuser system
  - b) Mechanical aeration system
  - c) Combination of Air diffuser and mechanical aeration system

Air diffuser system may be achieved by (i) Jet diffuser (ii) Plate diffuser (iii) Tube diffuser

**Sludge settlement**: The secondary sedimentation tank is the second unit. After agitation in aeration tank, the effluent is taken to the secondary settling tank and detained for a specified period, generally of 1 hr. During this detention period, the sludge is termed as activated sludge. Some portion of this sludge is recirculated to aeration tank and the remaining portion is sent to digestion tank. Thus, the cycle of activated sludge process goes on working.

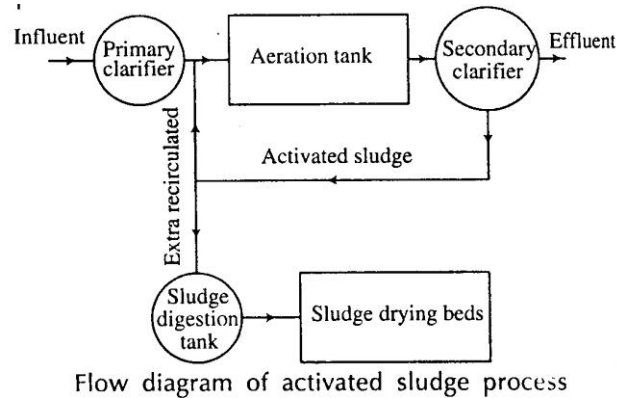

FIG.16.7

**AERATED LAGOON**

An aerated lagoon is an earthen basin about 2.5m to 4.0m deep, in which the sewage is filled and aerated by means of diffused air or mechanical aerators. Commonly mechanical aerators are used. These are firmly fixed on the permanent foundation. Sewage is sent in the lagoon after passing through the grit chamber, without giving any primary treatment. The aerated lagoon acts as a settling cum aeration tank, where artificial aeration replaces algae oxygenation of the waste stabilized ponds. The detention period of 3 to 5 days is provided. The efficiency of aerated lagoon is 70to 95% B.O.D removal. These are most suitable for middle size town as the initial cost of construction varies from Rs. 15 to 25 per capita. The waste water of industries such as paper , straw board and food industries can also be easily treated by aerated lagoons.

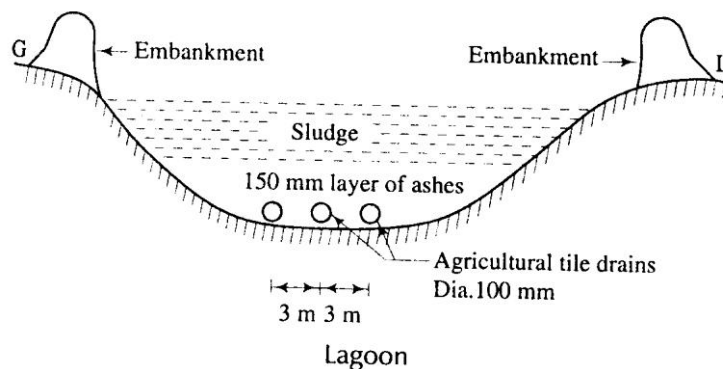

FIG.16.8

## OXIDATION DITCH

The oxidation ditches are aeration units in the shape of long channels 150 to 1000m long, 1 to 5m wide and 1 to 1.5m deep. mechanical aeration devices mainly consists of cylindrical cage about 75cm in diameter made of C.I., angle iron webs on which short (15cmx5cmx5cm), Tees or angle irons are mounted. These cylinders are kept at such a level that about 10 to 15 cm of them dipped in sewage. These cylinders are rotated at about 75 *r.p.m* . The rotor aerator aerates the sewage at a velocity of more than 30 cm/sec and keeps the solid content of the sewage in suspension condition. After aeration the sewage is allowed to settle in the settling tanks. The activated sludge is returned back to the aeration units. No primary treatments are given to sewage, so the methods are cross simplified. Sometime it acts as a settling unit. The rotors are stopped for 2 hours and the suspended solids settle in the bed, the effluent is taken out and disposed.

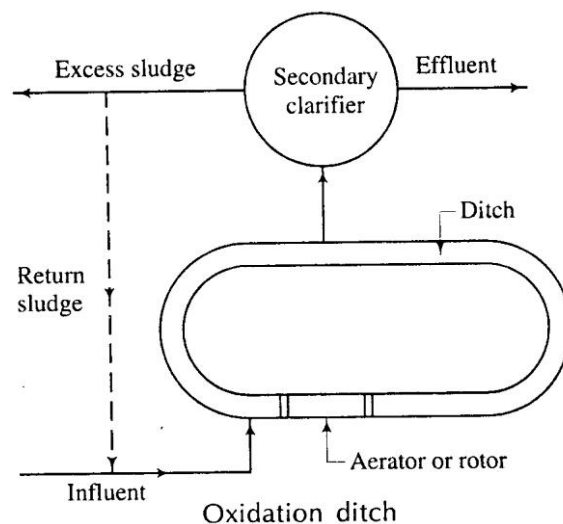

FIG.16.9

## SLUDGE DISPOSAL

Before disposing the sludge, the sludge digestion is to be done.

## SLUDGE DIGESTION

The decomposition of complex organic matters in sludge by the bio-chemical reactions created by anaerobic bacteria is termed as sludge digestion. A portion of solids is converted into liquid and gases due to which the volume is reduced by 60-75%.

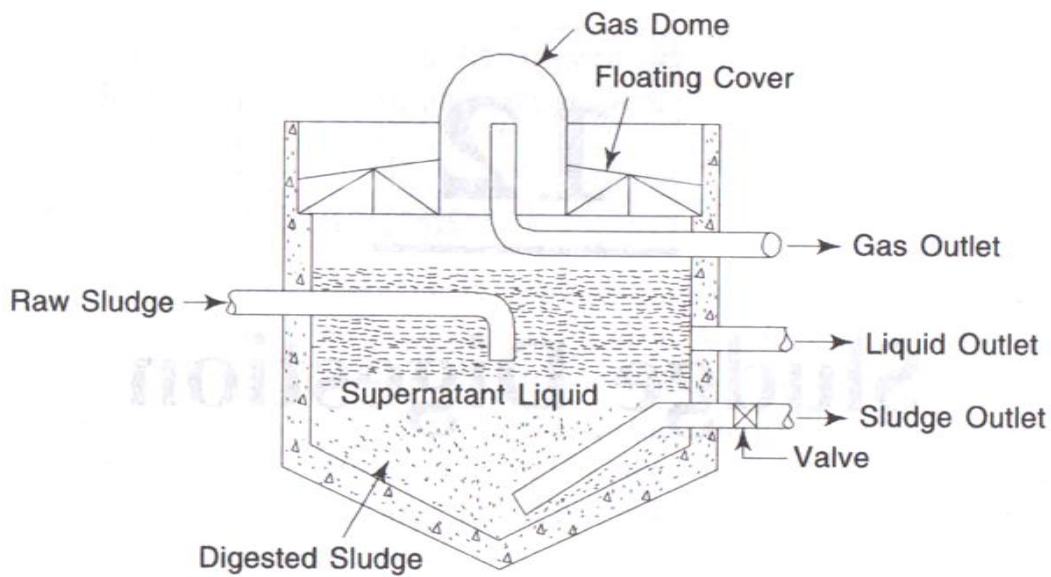

FIG.16.10

**Necessity of Sludge Digestion:** The following are the necessity of sludge digestion

- To destroy pathogenic bacteria.
- To reduce the volume of sludge so that it can be disposed of easily.
- To obtain combustible gases.
- To obtain good fertiliser.
- To reduce the moisture content for the facility of handling and transporting.

The sludge digestion is done in sludge digesters. There are 2 types of sludge digesters.

### SLUDGE DIGESTION TANK

#### Constructional features

**1. Enclosure tank :** The enclosure tank is generally circular in shape and is constructed with R.C.C. The diameter of the tank is varies from 5-20 m and depth varies from 3-5m. however the actual size depends upon in the volume of the sludge. The floor of the tank is made sloping like hopper and the slope is generally 1:2 or 1:3.

**2. Gas Dome:** A gas dome is provided with the floating roof for the collection of gas formed during the process of digestion.

**3. Inlet and Outlet:** An inlet pipe is provided for the entry of raw sludge. A sludge outlet pipe is provided at the bottom. Supernatant liquid outlets are provided at different levels. A gas outlet pipe is provided at the top for drawing the gases from dome.

**4. Mixing Device:** A suitable mixing device should be provided for mixing the incoming raw sludge with the digested sludge.



**5.Scum breaking device:** Some devices should be provided to break up the scum which may form at the top surface.

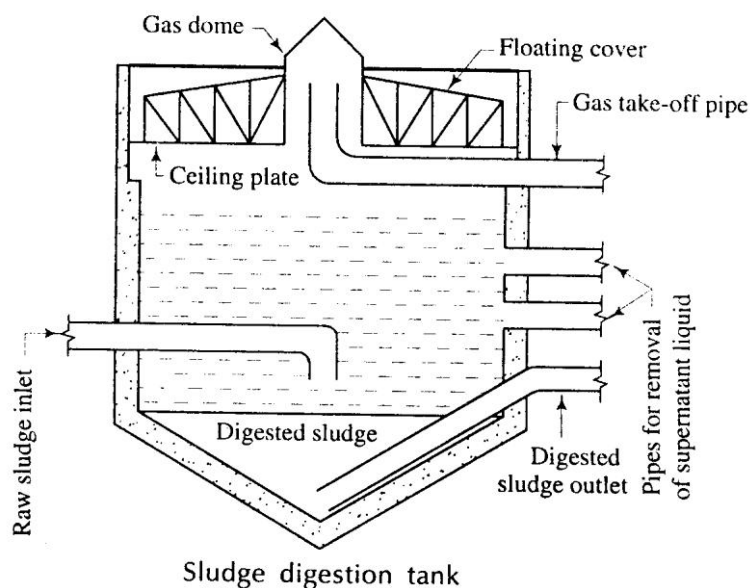

FIG-16.11

### Working principles

1. The raw sludge is allowed to enter the tank through the inlet pipe and is thrown at the centre of the tank.
2. The sludge is digested by the decomposition of complex organic matters by anaerobic bacteria.
3. The digested sludge is settled at the bottom of the tank which is withdrawn through the outlet valve and left for drying. The gases are collected at the dome. The gases are withdrawn through the outlet pipe and are used as fuel.
4. The supernatant liquid is collected, at the space between the digested sludge zone and the gas dome. This illiquid is withdrawn from different levels and disposed of in the natural water course.

### IMHOFF TANK:

In Inhoff tank, the sedimentation and digestion are carried out simultaneously. The following are the parts and working of Inhoff tank.

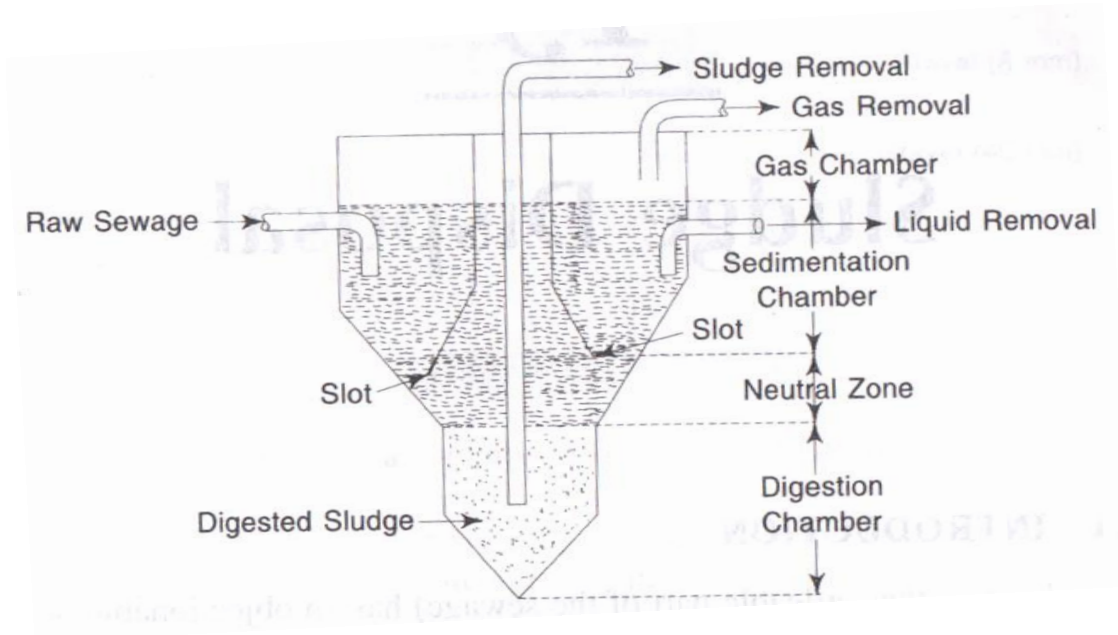

### INHOFF TANK

FIG.16.12

- (a) **Shape :** It is circular in shape with hopper like bottom and constructed in R.C.C.
- (b) **Sedimentation Chamber:** it is the central zone of imhoff tank. The sewage containing heavy sludge from the secondary clarifier is allowed to enter this chamber and is detained for specified period.
- (c) **Baffle plates and Slots :** The tank consists of baffle plates with hopper like bottom. Slots are provided between the baffle plates and the body of the tank. The sludge is generally settled down through the slots and deposited in the digestion chamber.
- (d) **Digestion Chamber:** This is the lower part of the Imhoff tank. In this chamber, the sludge is digested under anaerobic condition.
- (e) **Neutral Zone:** The space between the slot and the top digestion chamber is known as neutral zone. The depth of this zone is generally 30m. This zone prevents the entry of digested sludge into the sedimentation chamber.
- (f) **Gas Chamber:**It is the upper zone of the Imhoff tank. In this chamber, the gases (mainly methane) are collected which are withdrawn and used as fuel.
- (g) **Sludge Removal:** The digested sludge from the digestion tank is withdrawn through the sludge removal pipe and taken to the drying bed.

## DISPOSAL OF DIGESTED SLUDGE

The sludge obtained from all the sources has an objectionable odour and it possesses the property of pollution if not properly disposed of. The following are the methods of sludge disposal.

1. The sludge is disposed by spreading on drying bed to a thickness of 30cm. After 7 days, the sludge is ready to be removed and stored suitably for the use as manure. It should not come in contact with vegetables and fruits directly on soil.
2. The sludge is disposed by spreading over barren land at an interval of about 7 months and ploughed frequently which enhances the fertility of the land.
3. The sludge is disposed by pouring in trenches on barren land. The trenches are excavated on land perpendicular to each other at an interval of disposal period (about 1 month).
4. Where there is no utility of sludge, a very easy and cheap method of sludge disposal is throwing the sludge into the deep sea very far away from the shore ensuring that the sludge may not return to the shore.
5. The sludge is disposed by incineration. The sludge is burnt in incinerator of flash type (consists of a tower) or multiple hearth type (consists of a furnace). Ashes from incinerated sludge are used as a landfill.
6. Lagooning is one of the processes of sludge disposal. A lagoon is an artificial pond of depth of about 1m with the embankments on 2 sides. The lagoon is filled up with wet sludge and left for a few months. The sludge is dried and cracks are formed on the surface. Then the dried sludge is removed and used as manure. This is a very cheap method, if sufficient land is available.

## ISOLATED TREATMENT UNITS

### SEPTIC TANK

**1.Theory :** Septic tank is based on the principle of sedimentation of sewage and digestion of sludge. In this tank the sewage is detained for some period. During this detention period, the sewage is decomposed by anaerobic bacteria and the sludge is deposited at the bottom (as sedimentation tank). The digestion of sludge is carried out by the anaerobic bacteria (as

digestion tank). The effluent is clear and it is discharged into the soak pit constructed at a suitable place.

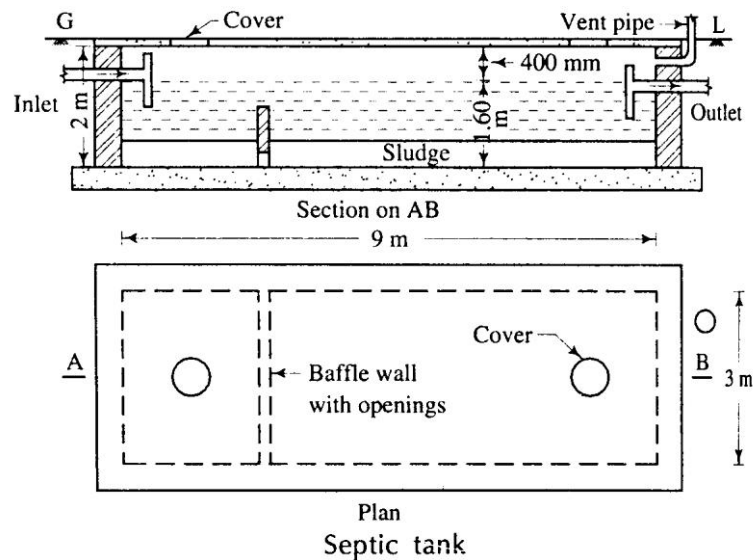

**FIG.16.13**

**2. Use :** the septic tank is suitable for the towns where it is not possible to establish the water carriage system. It is provided in residential buildings, hostels, hotels, hospitals, schools, colleges, etc.

**3. Constructional features:** Fig shows a septic tank. The following are the constructional features of septic tank:

- (i) It is a rectangular tank constructed with brick masonry over concrete foundation. The length is usually 3 times the breadth.
- (ii) The liquid depth varies from 100-180 cm.
- (iii) A free board of 30-50-cm is provided above the liquid level.
- (iv) The inlet pipe and outlet pipe consist of 'T' or 'elbow' which are submerged to a depth of about 25cm below the liquid level
- (v) The outlet level is about 15cm lower than the inlet level.
- (vi) The inside surface of tank should be plastered and finished with neat cement polish to make it complete watertight.
- (vii) For smaller tank single baffle wall should be provided. But for larger tank two baffles should be provided near both the ends.
- (viii) The top of the baffle should be at least 15cm above the liquid level.

(ix) Openings should be provided near the bottom of the baffle for the flow of effluent from first chamber to second chamber. Sometimes, hanging baffles may be provided.

(x) R.C.C. slab with manhole is provided at the top of the tank.

(xi) Ventilation pipe is provided for the removal of foul gas.

**4. Working Of Septic Tank:** The fresh sewage from the latrines enters the first chamber directly where the scum start floating at the beginning. Within few days, the anaerobic bacteria decompose the scum and sludge is formed which is settled down at the bottom of the tank, and it is digested further by those bacteria. The effluent from the first chamber flows to the second chamber through the opening in the baffle wall and finally disposed of to the soak pit. During the decomposition, the gases like carbon dioxide, methane and hydrogen sulphide are formed which are released through the vent pipe.

Due to the deposition of sludge, the capacity of the tank goes on reducing gradually. So, the tank should be cleared every year, or at some reasonable period.

**5. Design Aspects:** Following are the design aspects of the septic tanks:

(i) **Capacity:** The volume of septic tank is decided by taking into consideration the quantity of flow and detention period. It can also be designed on per capita basis which varies from 60-110 litres person to be served by the septic tank. The pace for sludge is kept usually at the rate of 15 to 45 litres per capita per year.

(ii) **Detention Period:** The detention period varies from 12 to 72 hours, the common being 24 hours.

(iii) **Freeboard:** This should be about 400mm to 600mm.

(iv) **Shape:** The septic tanks are generally rectangular in shape . The ratio of length to width is about 2 to 4.

### **SOAK PIT/ SOAK TRENCH**

**Function:** The function of soak pit is to receive effluent from the septic tank and disperse the liquid to the surrounding soil through the openings provided at the wall and through the bottom. The soak pit should not be constructed very near to an open well or tube well.

**Constructional Features:** The following are the constructional features of the soak pit:

(i) The soak pit is constructed with brick masonry in the shape of a square or circle. The depth varies from 3-5m. But the depth depends upon the water table of the locality. It should be remembered that the depth should not be taken below the water table.

(ii) The diameter of the pit depends on the volume of effluent and number of users. However,

the diameter varies from 1-2m.

- (iv) Openings are provided on the wall of the pit, as shown in fig. The bottom is kept open so that the water can be absorbed by the surrounding soil.
- (iv) The pit may be hollow or filled up with brick bats and brick khoa.
- (v) Sometimes, a packing of coarse sand (15 cm thick) is provided around the pit to increase the percolating capacity of the soil.
- (vi) If the soaking capacity of the pit is destroyed, it should be cleaned and filling materials may be replaced.

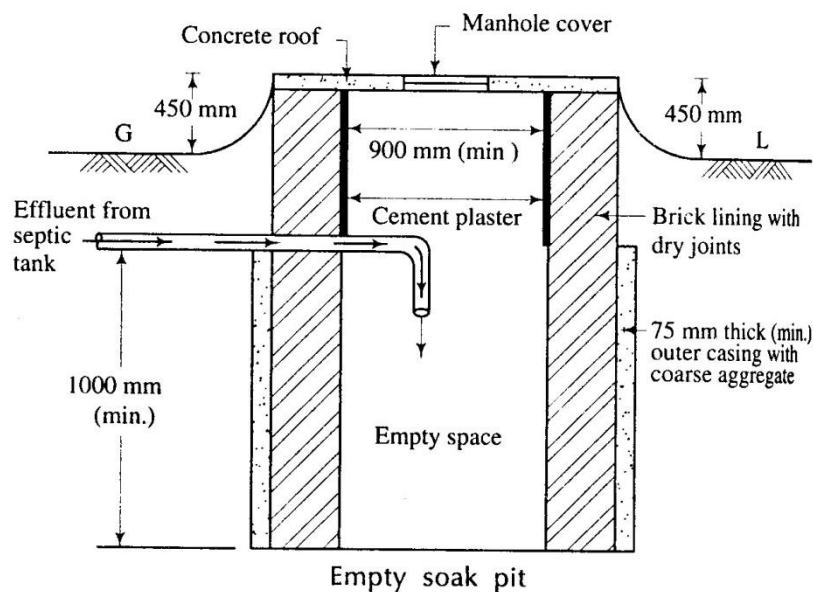

FIG.16.14

## DESIGN OF SEPTIC TANK AND SOAK PIT

### PROBLEM.

Design a septic tank having the following data;

- (i) Number of users-200
- (ii) Rate of water supply -150 lit/jead/day
- (iii) Detention period-18 hours
- (iv) Percolating capacity of filter media= 1250 lit/m<sup>3</sup>

Also find the diameter of the soak pit. Assume reasonable data, if required.

*Solution:*

Considering that the whole quantity of water comes as sewage,

Flow of sewage per day = 200 X 150

$$= 30000 \text{ lits.}$$

Detention Period is 18 hours.

$$\text{So, Tank capacity} = \frac{30,000 \times 18}{24} = 22,500 \text{ lits}$$

Assuming sludge storage capacity at the rate of 20 lits/person/year.

$$\begin{aligned} \text{Volume of sludge} &= 200 \times 20 \\ &= 4000 \text{ lits.} \end{aligned}$$

$$\begin{aligned} \therefore \text{Tank capacity} &= 22,500 + 4000 \\ &= 26,500 \text{ lits.} \end{aligned}$$

Considering 20% provision for future extension.

$$\text{Extra volume} = 26,500 \times 0.2 = 5,300 \text{ lits.}$$

$$\begin{aligned} \text{Total volume of tank} &= 26,500 + 5,300 \\ &= 31,800 \text{ lits} \\ &= 32,000 \text{ lits(say)} \\ &= 32 \text{ m}^3 \text{ [1m}^3 = 1000 \text{ lits]} \end{aligned}$$

Considering, the effective depth of liquid as 1.5m.

$$\text{Cross-sectional area} = \frac{32}{1.5} = 20.6 \text{ m}^2.$$

$$\begin{aligned} \text{Let,} & \quad \text{width} = b \\ \text{and} & \quad \text{length} = 3b \\ & \quad b \times 3b = 20.6 \\ \text{or} & \quad 3b^2 = 20.6 \\ \therefore & \quad b = 3.0 \text{m (say)} \\ \therefore & \quad \text{Length} = 3 \times 3 = 9 \text{ m.} \end{aligned}$$

Considering free board as 0.5m.

$$\text{Overall depth} = 1.5 + 0.5 = 2 \text{m.}$$

Therefore, the size of septic tank is 9m x 3m x 2m.

### **Size of Soak well**

$$\text{Volume of soak well} = \frac{32 \times 1000}{1250} = 25.6 \text{ m}^3$$

[As Percolation Capacity = 1250 lits/m<sup>3</sup>]

## **OXIDATION POND**

**Theory** The oxidation pond is an excavation of rectangular ditch of shallow depth. The sewage is stored in this pond for a considerable time. During this period, the sewage is

decomposed by the action of aerobic bacteria, algae and sunshine. That means, it is a natural method of sewage treatment. The aerobic bacteria absorb oxygen from the atmosphere for their survival and break up the organic matters in sewage to simple stable compounds.

**Construction and Operation** The oxidation pond is constructed by excavating a rectangular ditch of shallow depth. The length varies from 50-100m, the width from 30-50m and the depth varies from 0.9-1.5m. The pond is divided into several compartments. The sewage is allowed to enter the pond through the inlet channel at one corner. The sewage flows in a zig-zag manner until the whole pond is filled up. The detention period varies from 7-14 days. The decomposition of sewage is achieved by the aerobic bacteria. After complete decomposition black humus is obtained which may be used as manure.

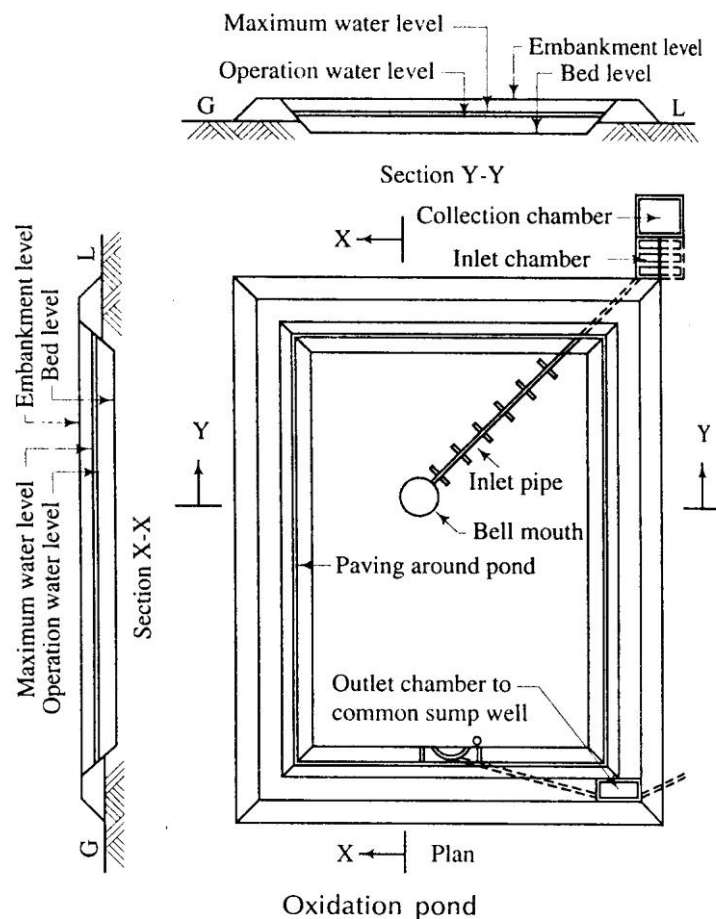

**FIG.16.15**

**Advantages**

- (a) It is a natural method of decomposition, so it is cheap.
- (b) Its operation and maintenance is simple.
- (c) It is highly efficient in removing B.O.D.



***Disadvantages***

- (a) Large area is required for treatment.
- (b) It creates bad smell and mosquito nuisance.
- (c) In rainy season or cloudy weather, the sewage becomes septic and this may cause insanitary condition.

## CHAPTER-17

### SANITARY PLUMBING FOR BUILDING

#### Requirements of building drainage

- (1) It is advisable to lay sewers by the side of building rather than below the building.
- (2) The drains should be laid straight between inspection Chambers or manholes. All sharp Bends and junctions should be avoided except through chambers or manholes.
- (3) The house drain should be connected to the public sewer only if the level permits i.e., only when public sewer is Deeper than the house drain. Otherwise there will be reverse flow from the public sewer to the house drain.
- (4) The entire system should be properly ventilated from the starting point to the final point of disposal.
- (5) The house drainage should contain enough number of traps at suitable points for efficient functioning of it.
- (6) The house drain should be disconnected from the public by the provision of an intercepting trap so as not to allow foul gases from the public sewer to enter the house drain.
- (7) The joints of sewers should be watertight and properly tested before putting the drainage line n use.
- (8) The lateral sewers should be laid at proper gradation so that they will develop self-cleansing velocity.
- (9) The layout of house drainage system should permit easy cleaning and removal of obstructions.
- (10) The materials of sewer should comply with the standard requirements. They should be non-absorbent and an earth cushioning should be provided to protect them from external loads.
- (11) The possibilities of formation of air locks, siphonage, undue deposits, etc. should be properly studied and remedies should be accommodated in the design to avoid them.
- (12) The rain water from houses is collected from roofs and it is allowed to flow freely on the road surface basins or inlets to convey it to the storm water drain.
- (13) The sewage formed should be conveyed as possible after its formation.

(14) The size of lateral sewers should be such that not overflow at the time of maximum discharge.

**DRAINAGE PLANS OF BUILDINGS:**

It is necessary to prepare the detailed plans showing the proposed house drainage system and to get it approved or sanctioned from the competent authority. Following points should be noted:

- (1) The site plan of the building should be drawn to the convenient scale and positions of gully marked on it as shown in fig. 17.1.
- (2) The longitudinal section of proposed sewer line should show distances drawn to a convenient scale. Generally the longitudinal sections of drains greater than 150 mm in diameter drawn.
- (3) The longitudinal sections should show distances, ground levels, invert levels, depths of cutting, sizes of chambers and manholes, size and gradient of pipes, etc. as shown fig. 17.1
- (4) The position of public sewer should be clearly shown the site plan and longitudinal section of drain. It is advised to join the house drain to a manhole on public sewer

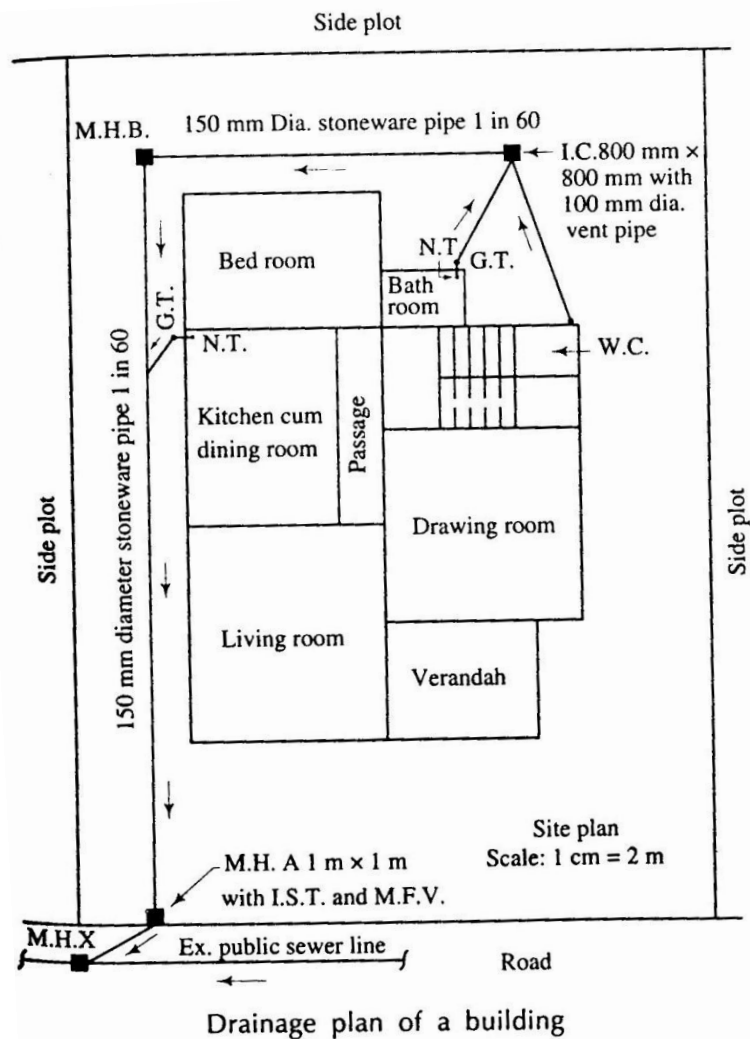

Fig.17.1

### LAYOUT OF LAVATORY BLOCKS IN RESIDENTIAL BUILDING

The scale of provision of sanitary facilities in a building will be dictated by the nature and size of the building, the overall building occupancy, gender ratio, and particular patterns of use. These factors should be considered alongside the diversity of building user needs to establish the range, location, and type of facilities that will provide access for all.

The number and range of sanitary appliances should be established at an early stage in the design process and should involve consultation with users as well as with the local planning, building control and environmental health, and relevant licensing authorities, where applicable.

The gender ratio should take account of the likely proportion of males and females but also acknowledge the fact that, for physiological and social reasons The British

Toilet Association recommends the following ratio of provision: Number of male cubicles plus number of male urinals x 2 = required number of female cubicles.

The pattern of use of a building will affect the demand on sanitary facilities and may influence the number, type, and location of facilities provided. In an office, for example, the toilets are likely to be accessed intermittently throughout the day. By contrast, the toilets in an assembly building, such as a theatre, cinema, or entertainment arena will be accessed by a large number of people in a very short time frame, such as immediately before or after the performance, or during the interval. In this case, the number of toilets should be based on the maximum number of people likely to require the facilities at any particular time.

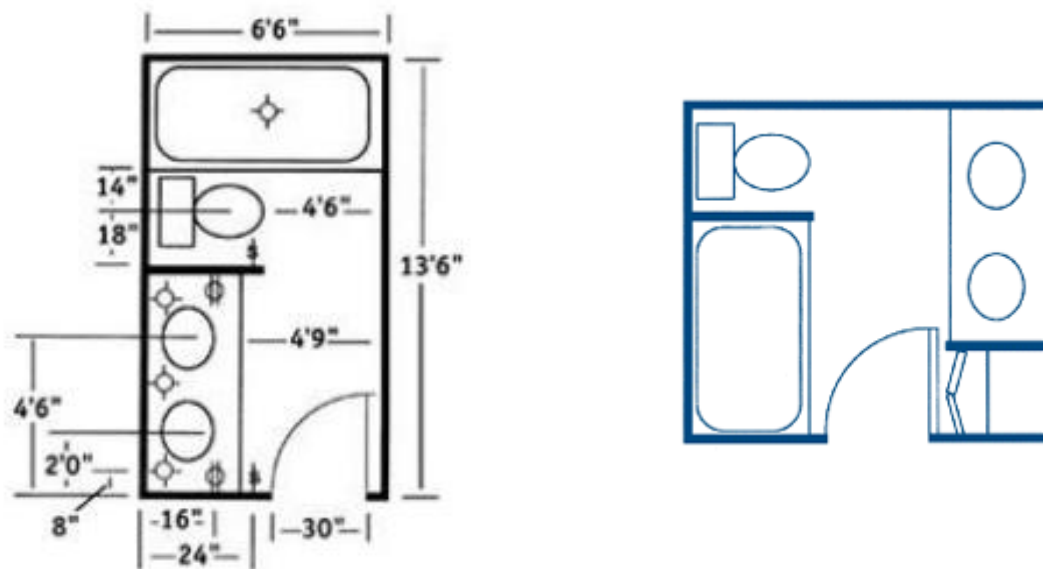

Layout Of Lavatory Blocks

Fig.17.2

### PLUMBING ARRANGEMENT IN A MULTI STORIED BUILDING DISTRIBUTION SYSTEM

There are four basic methods of distribution of water to a multi-storeyed buildings.

- (i) Direct supply from mains to ablutionary taps and kitchen with WCs and urinals supplied by overhead tanks.
- (ii) Direct Pumping Systems
- (iii) Hydra-pneumatic Systems
- (iv) Overhead Tanks Distribution

#### Direct Supply System –

This system is adopted when adequate pressure is available round the clock at the topmost floor. With limited pressure available in most city mains, water from direct supply is normally not available above two or three floors. Water is pumped directly into the distribution system without the aid of any overhead tank, except for flushing purposes. The pumps are controlled by a pressure switch installed on the line. Normally a jockey pump of smaller capacity installed which meets the demand of water switch is installed to restrict the operating cycle during low consumption and the main pump starts when the demand is greater. The start and stop operations are accomplished by a set of pressure switches arc installed directly on the line. In some installation, a timer of the pump.

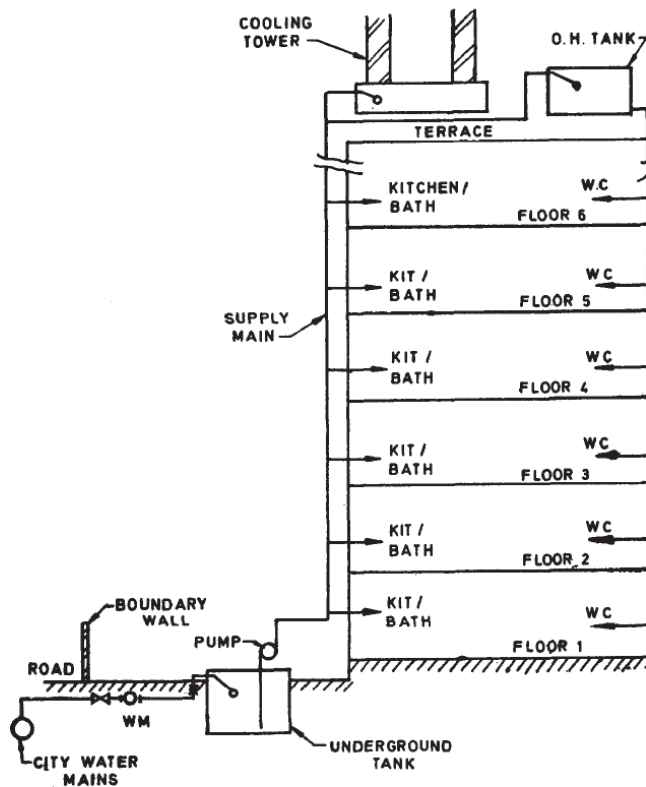

**Direct Supply System**  
**Fig.17.3**

### ADVANTAGES OF DIRECT PUMPUNG SYSTEM

(i) Direct pumping systems are suitable for buildings where a certain amount of constant use of water is always occurring. These buildings are all centrally air-conditioned buildings for which a constant make up-supply for air-conditioning cooling towers is required.

(ii) The system depends on a constant and reliable supply of power. Any failure in the power system would result in a breakdown in the water supply system.

(iii) The system eliminates the requirements of overhead tanks for domestic purposes (except for flushing ) and requires minimum space.

### **Hydro-pneumatic System**

- (i) Hydro-pneumatic system is a variation of direct pumping system. An air-tight pressure vessel is installed on the line to regulate the operation of the pumps. The vessel is arranged to consist of approximately half the capacity of water. As pumps operate, the incoming water in the vessel compresses the air on top. When a predetermined pressure is reached in the vessel, a pressure switch installed on the vessel switches off the pumps. As water is drawn into the system, pressure falls into the vessel starting the pump at preset pressure. The air in the pressure tank slowly reduces in volume due to dissolution in water and leakages from pipe lines. An air compressor is also necessary to feed air into the vessel so as to maintain the required air-water ratio.
- (ii) There are various types of system available in the market and the designers has to select the system according to the needs of each application.
- (iii) Hydro-pneumatic system generally eliminates the need for an over head tank and may supply water at a much higher pressure than available from overhead tanks particularly on the upper floors, resulting in even distribution of water at all floors.

### **Overhead Tank Distribution**

- (i) This is the most common of the distribution systems adopted by various type of buildings.
- (ii) The system comprises pumping water to one or more overhead tanks placed at the top most location of the hydraulic zone.

### **SANITARY FIXTURES**

In case of buildings various types of sanitary fittings are required to collect the sanitary waste from the building.

The fittings can be classified as below.

(A) Ablution fittings

- Wash basins
- Sinks
- Bath tubs
- Flushing cisterns
- Drinking fountains

(B) Soil fittings

- Water closets
- Urinals
- Slop sinks

All type of sanitary fittings should be fixed against the external wall, so that the buildings can be ventilated with light and air. The floor and wall material should be non-absorbent with curved angle at the junctions.

**FLUSHING CISTERNS:-**

These are used for flushing water closets and urinals after use.

There are several varieties of flushing cisterns. High level cisterns are intended to operate with a minimum height of 125 cm between the top of the pan and the underside of the cistern. Low-level cisterns are intended to operate at a height not more than 30 cm between the top of the pan and the underside of the cistern.

Cistern may be of cast iron, glazed earthenware, glazed vitreous ware or pressed steel or any other impervious material.

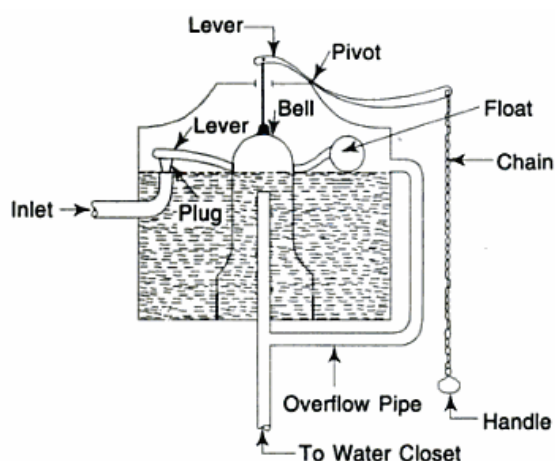

**Fig.17.4**

Two common types of cisterns are



- i) Bell type without valve
- ii) Flat bottom type fitted with valve

Figure shows a bell type flushing cistern.

The bell is kept over the outlet pipe, the inlet end of which is slightly above the water level. When the chain is pulled the bell is lifted causing the water to spill over the outlet pipe and starting the siphonic action due to which the whole water rushes towards the outlet and flushes the water closet.

Due to shortage in the water supply, there was urgent demand to reduce the quantity of water consumption. All flushing cisterns available and existing in the building fittings, discharge their full quantity of water even for small purposes even when small quantity of water will be sufficient for that purpose.

### WATER-CLOSET

This is a sanitary appliance to receive the human excreta directly and is connected to the soil pipe by means of a trap.

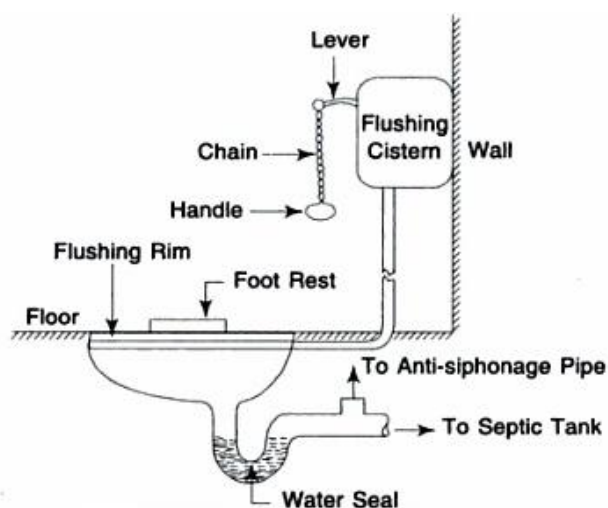

Water Closet  
Fig.17. 5

The water closets are classified as follows

#### (A) SQUATTING TYPE OR INDIAN TYPE

- (I) Long pan pattern (length 4560, 5680, 680 mm)
- (II) Orissa pattern (length 580,630,680 mm)
- (III) Rural pattern (length 425 mm)
- (B) Wash-down, pedestal or European type

Figure 17.5 shows the section through an Indian type water closet. This is manufactured in two different pieces. I) squatting type II) trap.

The pan is provided with an integral flushing rim of suitable type. The inside of the bottom of the pan should have sufficient slope towards the outlet for the quick disposal during flushing.

These are made of vitreous china clay. The inner portion is glazed to make it easy in cleaning. The pan is connected to the flushing cistern by means of flushing pipe. The top of the trap is connected to the anti-siphon or vent pipe.

Figure shows the pictorial view of an Indian type water closet.

Figure shows the section through a wash-down water closet which is most commonly used in high class buildings. It is provided with a wide flushing rim and 5 cm trap. It is one piece construction in which the pan and trap are not separate. It is provided with a water inlet or supply horn for connecting to the flushing pipe. It may be provided with P and S trap as desired. These types of water closets requires less space than squatting pattern type and can be flushed by low level cistern. Now a days siphonic water closets are very popular.

Bowl type urinals are one piece construction, each is provided with two fixing holes on the side for fixing it on the wall. At the bottom an outlet horn is provided for connecting it to the trap. The inside surface is regular and smooth for ensuring efficient flushing. The bottom of the urinals is provided with sufficient slope from the front towards the outlet for efficient drainage of the urinals. Bowl type urinals are also provided with flushing rim which is connected by flushing pipe to the flushing cistern. Figure shows a bowl type urinal.

The slab and stall type of urinals are manufactured either as a urinal or as a range of two or more and are used in public places such as cinema halls, restaurants, railway stations, offices etc.

The squatting type urinals are mostly used in ladies lavatories.

## **REQUIREMENTS OF SANITARY FITTINGS**

The requirement of sanitary fitting depends upon the persons using them and the circumstances, type of building etc

### **TRAPS**

Foul gases produced in the sewers , drains, waste pipes may cause nuisance by entering in the houses through house –connecting pipes. If their passage is not checked by some suitable devices. The devices which are used to stop the escape of foul gases inside or outside the houses are known as traps. The traps generally consist of a bend tube which provides a water

seal between the atmosphere and the sewer gases. The efficiency of the traps depends on the depth of water seal, deeper the seal more efficient will be the trap.

The following are the requirements of a good trap.

- (i) It should be made of non-absorbent material.
- (ii) It should provide sufficient depth of water seal all times ( about 50 mm ) having large surface area.
- (iii) It should be self-cleaning and should not obstruct the flow of sewage.
- (iv) It should be provided with access door for cleaning.

The water seal of the traps can break due to the following conditions:-

- (i) If there is any crack in the bottom of the seal or the joint is faulty.
- (ii) If for a long time the seal is not in use, it's water will evaporate in the atmosphere.
- (iii) If due to blockage or any other reason there is an increase in the pressure of the sewer gases, it will pass through the water of seal.
- (iv) If partial vacuums are created in the sewer fittings, it will suck up the seal water. To avoid the breakage due to this reason, the portion between the trap and the soil pipe should be connected to the vent pipe.

### TYPES OF TRAPS

The following are the types of traps most commonly used

#### (a) P, Q, and S- TRAPS –

These traps are classified according to their shape. As shown in 17.6 figure. They essentially consist of a U- tube which retains water acting as a seal between the foul gas atmosphere.

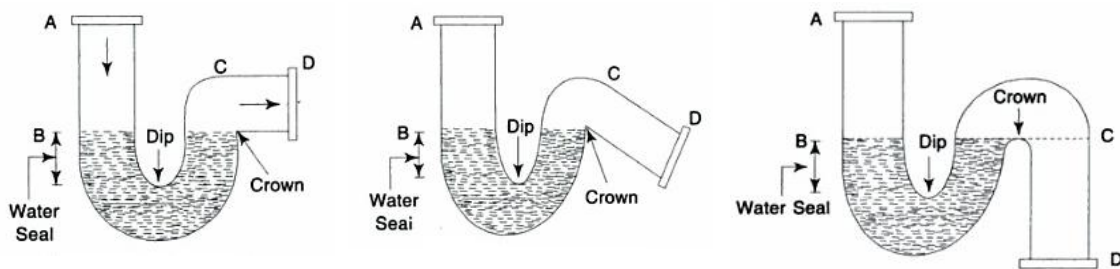

(a) P-Trap

(b) Q-Trap

(c) S-Trap

Fig.17.6

**(b) Gully traps:-**

This trap is provided at different places in the drain pipes. Waste water from sinks, bath etc. Enters in through back inlet and outlet water from the sweeping of the rooms, courtyards etc. Enters from the top, where a coarser screen grating is fitted to check the solid matter. figure shows a gully trap.

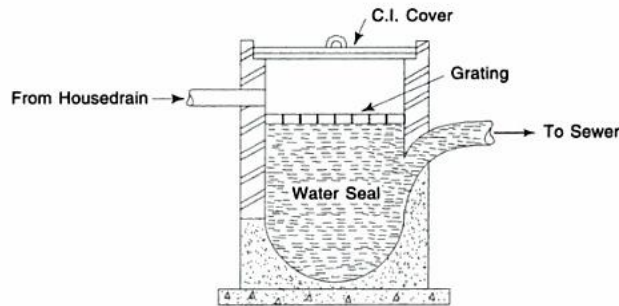

**Gully Trap**

**Fig. 17.7**

**(c) An intercepting trap**

The sewage from every house goes in street sewers which carry it away from the city. The street sewers contain foul gases in it and if their passages are not checked from street sewers to the house. They may enter in the house drain and pollute the atmosphere. For this purpose a trap in one inspection chamber is provided outside the houses, which is called an intercepting trap. This trap is provided at the top with a cleaning eye with a plug. Figure shows this type of trap.

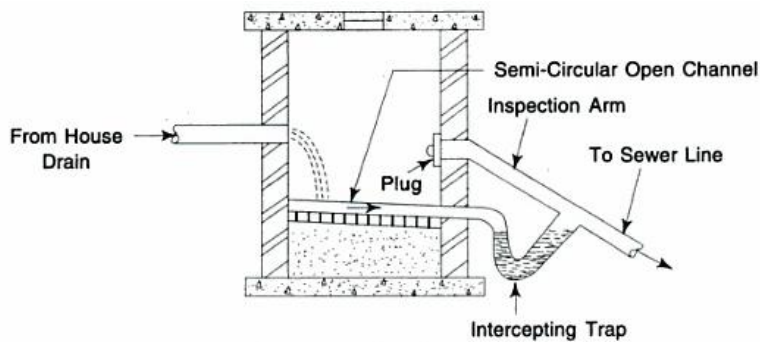

**An intercepting trap**

**Fig.17.8**

**(d) Anti -D traps**

P, Q and S traps are largely used for baths, sinks and lavatories. In such cases, they are made with enlarged mouth so that the waste pipe may be thoroughly flushed out. But in these traps full bore is nit interfered with by the discharge. These traps are made of ordinary circular sections. Anti -D pipes are an improvement over the above traps which are made by Mr. Melleyer of

England. By a series of experiment Mr. Melleyer found that the driven out of water momentum of the change from the trap can be prevented by so shaping the trap that the water – holding portion is contracted and the outgo is large and square. This trap also prevents siphonic action . The water –way in the anti- D trap is reduced which ensures the removal of all refuse, while the outlet being larger prevents the pipe from filling full and causing siphonic action.

**(e) Anti- siphonic trap –**

These are several types of anti-siphonic traps in the market, which are also called re –called trap. These traps avoid the connection to the vent pipe and reduce this expensive work. Grevak trap which is most common. The construction of this trap is such that when water seal is subjected to the pull due to the siphonic action, the heavier atmospheric pressure on the inlet side presses the water down and the air can pass from by- **pass tube B**.

**FIXING AND JOINING OF PIPE ACCESSORIES-**

Rain water, soil waste and vent pipes can be embedded in the walls or floors or can be fixed in them. When they are embedded no fixing devices are required. But for ease in repair and maintenance usually they are fixed on the outside of the walls. For fixing them special type of breaks are required. It is the most common type of fixing bracket having aluminium painted clips. These brackets fix closely round the pipe or accessory directly beneath the socket and have ears for securing to the face of the face of the structure. When they are fixed, they present a neat appearance.

The joining of pipe accessories are done as follows. First gasket or hemp yarn saturated with bituminastic jointing compound is caulked about 2.5 cm depth. Then the space between the collar and plain end is ground with stiff mortar of cement. Figure shoes the method of jointing.

After fixing and jointing all pipes and accessories must be tested for water tightness. This is done by dividing the whole work in sections and testing each section one by one.

**PIPES AND PIPE FITTINGS**

Various types of materials which are used in the construction of sewer pipes are cement concrete, cast iron, brick, vitrified clay etc . All these materials are also used in the construction of pipe required in the house drainage. In the house drainage works stone work, asbestos cement lead and iron pipes are used.

## SYSTEM OF PLUMBING

Following are the main systems of plumbing for the building drainage.

### (a) **TWO-PIPE system**

This is the most common type of system used in India. This provides an ideal solution, where it is not possible to fix the fixture closely. In this system, two pipes are provided. One pipe collects the foul soil and lavatory wastes, whereas the second pipe collects the unfoul water from kitchen, bathrooms, house washings and rain water. Etc. The soil pipes (pipes carrying the soil waste) are directly connected to the drain, whereas the waste pipes (pipes carry unfoul water) are connected through the trapped gully. All the traps used in this system are fully ventilated.

### (b) **ONE – PIPE system**

In this system only one main pipe is provided which collects foul soil waste as well as unfoul soil waste from the building. The main pipe is directly connected to the drainage system. If the system is provided in multi-storeyed building the lavatory blocks of various floors are so placed one over the other, so that the waste water discharged from the different units can be carried through short branch drains. Figure shows the line diagram of this system.

All the W.C, basin sinks, etc. Are fully ventilated and connected to the ventilation pipe. But all gully traps and waste pipes are completely dispensed with.

### (c) **Single- stack system**

This is similar to single pipe system, the only difference being that no ventilation is provided even in the traps too.

### (d) **SINGLE STACK PARTIALLY VENTILATED SYSTEM**

This system is in between the one pipe and single –stack system. In this system only one pipe is provided to collect all type of waste water foul as well as unfoul. A relief vent pipe is provided for ventilating only the water closet traps.

Now a day in modern multi –storeyed building one pipe system is becoming popular. Due to its low cost. An analysis of this system showed that the

flow from the applicant to the stack through branch is momentarily halted at the sharp changes of flow from of direction. Sometimes a plug of water is formed immediately at the junction, which depends upon the rate of change of discharge and size if branch. This gives rise to unequal pressures at the seals, for the lower floors of the building and sometimes it breaks the water seals of the sanitary appliance.

The function of the aerator is to prevent the formation of the plugs of water in the vertical stack and to make a mixture of water and air of low specific gravity. The aerators are provided at every floor.

- (a) For supply of water to various sanitary fittings.
- (b) For collection of waste water from various sanitary fittings.
- (c) For collection of rain water from roofs, house and court-yard washings.

The fixings of sanitary appliances in the walls, floors and other places and their connected pipe works are to be done carefully for their proper functioning.

Deaerators are provided at the foot of the stack to separate air and water to avoid excessive back pressure. Stack of these fittings can be safely used up to 15 storeys. Where as a single stack system without these fittings can be used up to 5 storeys.

## CHAPTER-18

### RURAL WATER SUPPLY & SANITATION

#### **Springs:**

Sometimes ground water reappear at the ground surface in the form of springs. Springs generally can supply small quantity of water, hence these cannot be used as source of water to big towns. Due to presence of sulphur in certain springs, they discharge of hot water. Such hot water springs are only useful for taking dips for the cure of certain skin disease patient.

When the surface of the earth drops sharply the water bearing stratum is exposed to the atmosphere and springs are formed.

It is common practice to construct pucca tank at the point of springs to collect the spring water and prevent its wastage. To safeguard against the contamination of water. These tanks are covered from three sides with masonry walls, and roof is provided at the top. At the front side door is provided which is closed during nights, and it prevents the wild animals to contaminate water also. In Garhwal district these collecting works are known as '**Diggis**'.

#### **Spring Development and Protection**

Springs occur wherever groundwater flows out from the earth's surface. Springs typically occur along hillsides, low-lying areas, or at the base of slopes.

A spring is formed when natural pressure forces groundwater above the land surface. This can occur at a distinct point or over a large seepage area. Springs are sometimes used as water supplies and can be a reliable and relatively inexpensive source of drinking water if they are developed and maintained properly.

#### **Spring Development Considerations**

When considering using a spring as your source of drinking water, it is important to ensure that the rate of flow is reliable during all seasons of the year. Spring flow that fluctuates greatly throughout the year is an indication that the source is unreliable or may



have the potential for contamination. It may be possible to learn about historical spring flow from the previous owner or a neighbour.

Water quality is also important to consider before using a spring as a water supply. Before developing the spring, collect a sample of water and have it analyzed at a local water testing laboratory to ensure that it can be efficiently and economically treated to make it safe for human consumption. Springs are highly susceptible to contamination since they are fed by shallow groundwater, which usually flows through the ground for only a short period of time and may interact with surface water. For this reason, most springs will need some treatment before the water is considered a safe source of drinking water. Testing will help determine exactly how much treatment will be necessary and may help determine if other sources of water would be more economical.

### **Preparing for Spring Development**

Since springs are usually fed by shallow groundwater, water quantity may be an issue during certain times of the year. If possible, the flow rate for your spring should be monitored for an entire year, but it is most critical to measure the flow rate during late summer and fall when groundwater levels and spring flows are usually at their lowest. Springs used for drinking water supplies should yield at least 2 gallons per minute throughout the entire year unless water storage is going to be used. The amount of water you will need from your spring depends entirely on your household's daily water needs. Water needs for an individual home vary depending on water use, water storage, and water-saving devices within the home. However, the average home will require approximately 50 to 75 gallons of water a day per person.

The flow rate of a spring can be tested by digging a 5-gallon bucket into the slope of the spring and allowing the water to flow into the bucket. Determine the flow rate by timing how long it takes the water to fill the bucket. Obtain a sample collection container from a certified water lab and send a sample of the spring water to the lab for water quality testing. . You can start development of your spring once you determine that the quantity and quality are acceptable.

### **Spring Development**

---

A spring can be developed into a drinking water supply by collecting the discharged water using tile or pipe and running the water into some type of sanitary storage tank.

Protecting the spring from surface contamination is essential during all phases of spring development. Springs can be developed in two different ways and the method you choose will depend on whether it is a concentrated spring or a seepage spring. The general procedures for spring development are outlined in the following pages. Some of the methods for spring development outlined in this fact sheet are adapted from the Midwest Planning Service publication titled Private Water Systems Handbook.

### Spring Development Procedures: Concentrated Springs

A concentrated spring typically occurs when groundwater emerges from one defined discharge in the earth's surface. Concentrated springs are visible and are often found along hillsides where groundwater is forced through openings in fractured bedrock. This type of spring is relatively easy to develop (see Figure 1) and is usually less contaminated than other types of springs.

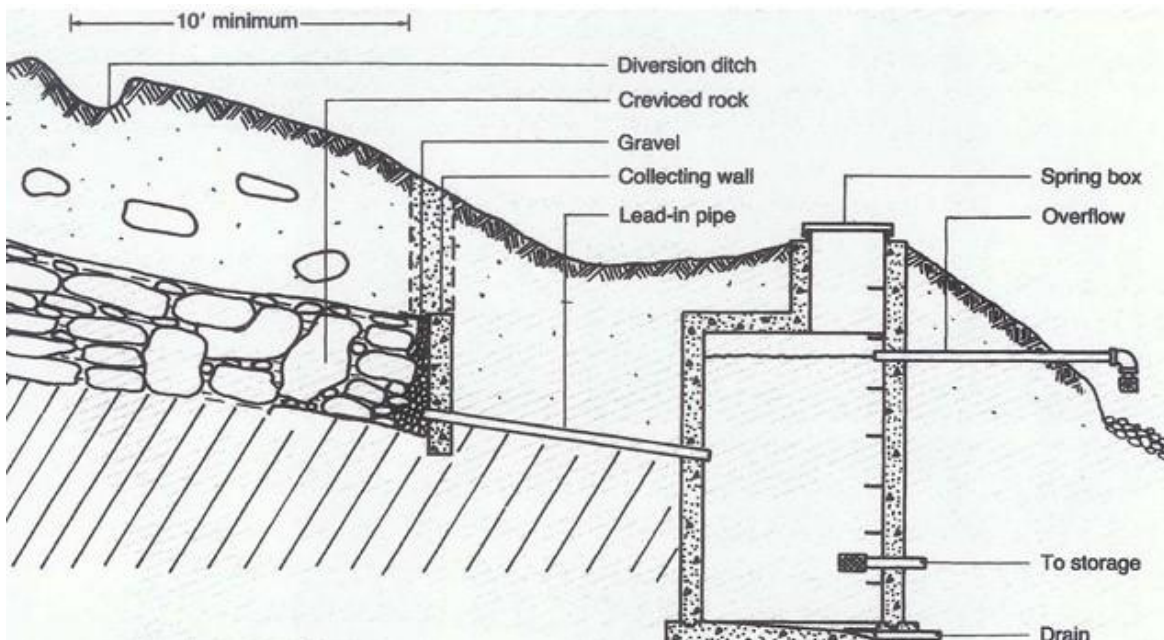

Development of a concentrated spring

Figure 18.1

### Steps for Developing a Concentrated Spring

- Excavate the land upslope from the spring discharge until three feet of water is flowing.
- Install a rock bed to form an interception reservoir.
- Build a collecting wall of concrete or plastic down slope from the spring discharge.
- Install a pipe low in the collecting wall to direct the water from the interception reservoir to a concrete or plastic spring box. (*Note: problems with spring flow can occur if water is permitted to back up behind the wall.*)
- Remove potential sources of contamination and divert surface water away from the spring box or collection area.
- Alternative types of interception reservoirs and collecting walls can be constructed as shown in Figure 2 on the following page.

### Proper Management of Springs

- **Remove Sources of Contamination**  
No matter what type of spring you have developed, it is critical that you remove potential sources of contamination from the spring's drainage area (the area upslope of the spring discharge point). Surface water draining into that area should be redirected and all activities should be limited within the drainage area. If livestock are present, fences should be used to keep animals from contaminating the drinking water supply.
- **Water Testing and Disinfection**  
Once the spring is developed and nearby sources of contamination are eliminated, it is important to disinfect the entire water system and then submit a water sample to a state certified water testing laboratory for water quality analysis. If a water test indicates bacterial contamination, check the water supply location and construction of the system for potential pollution pathways. If improvements can be made, the system should then be shock chlorinated. After two weeks, the water should be retested by a state-certified water testing laboratory. If the water again tests positive for bacterial contamination, the owner has the option of finding a new source of water or installing a continuous disinfection system, such as an ultraviolet light. Most springs used for

drinking water will require some type of continuous disinfection system to make certain that the water is safe for consumption.

## **Rainwater harvesting**

### **Introduction**

Where there is no surface water, where groundwater is deep or accessible due to hard conditions, or where it is too salty, acidic or otherwise unpleasant or unfit to drink, another source must be sought. In areas that have regular rainfall, the most appropriate alternative is the collection of rain, called 'rainwater harvesting'.

Falling rain can provide some of the cleanest naturally occurring water that is available anywhere. This is not surprising, as it is a result of a natural distillation process that is at risk only from airborne particles and from man-made

### **Advantages of rainwater harvesting**

- ✓ Relatively cheap materials can be used for construction of containers and collecting surfaces
- ✓ Construction methods are relatively straightforward
- ✓ Low maintenance costs and requirements
- ✓ Collected rainwater can be consumed without treatment, if a clean collecting surface has been used
- ✓ Provides a supply of safe water close to homes, schools or clinics, encourages increased consumption, reduces the time women and children spend collecting water, reduces back strain or injuries from carrying heavy water containers

### **Disadvantages of rainwater harvesting**

- ✗ Supplies can be contaminated by bird/animal droppings on catchment surfaces and guttering structures unless they are cleaned/flushed before use
- ✗ Poorly constructed water jars/containers can suffer from algal growth and invasion by insects, lizards and rodents. They can act as a breeding ground for disease vectors if they are not properly maintained

### **How it works**

Rainwater can be collected from most forms of roof. Tiled roofs, or roofs sheeted with corrugated mild steel etc are preferable, since they are the easiest to use and give the cleanest water. Thatched or palm leafed surfaces are also feasible, although they are difficult

to clean and can often taint the run-off. Asbestos sheeting or lead-painted surfaces should be avoided.

The rainwater is collected in guttering placed around the eaves of the building. Low cost guttering can be made up from galvanised mild steel sheeting (a thickness of around 22 gauge), bent to form a 'V' and suspended by galvanised wire stitched through the thatch or sheeting, as shown in Figure 1.

The guttering drains to a down-pipe, which discharges into a storage tank. The down-pipe should be made to swivel so that the collection of the first run-off can be run to waste (the first foul flush), preventing accumulated bird droppings, leaves, twigs and other vegetable matter, as well as dust and debris, from entering the storage tank. Sometimes a collecting box with a mesh strainer (and sometimes with additional filter media) is used to prevent the ingress of potential pollutants.

Fig 1: Guttering materials 3

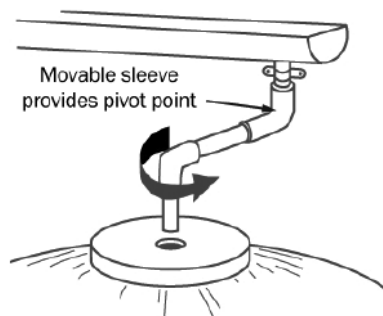
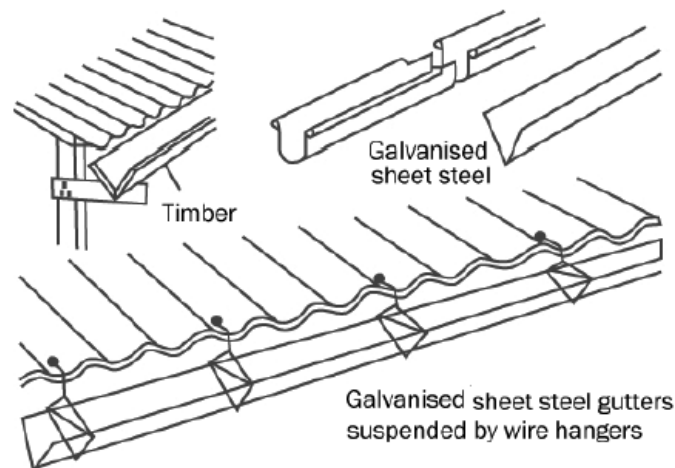

Fig.18.2

### Technical brief

Rainwater harvesting alternatively, a foul flush box, which can be drained separately, may be fitted between the down-pipe and the storage tank.

The run-off from a roof is directly proportional to the quantity of rainfall and the plan area of the roof. For every one millimetre of rain, a square metre of roof area will yield one litre of water (disregarding evaporation, spillage losses and wind effects). The guttering and down-pipes should be sized so as to be capable of carrying peak volume of run-off; in the tropics this can occur during high intensity storms.

### Storage tanks

The capacity of the storage tank is based upon several design criteria: rainfall patterns and volume, the duration of the dry period and the estimate of demand. Sometimes sophisticated calculations are involved, but these tend not to take into account human behaviour and the willingness to use water if it is available and not conserve it for future use, in the hope that the dry spell will soon be over.

The following simple calculation can be used to approximate the potential supply of rainwater from a collecting surface. This can help to determine the capacity of storage tanks:

$$S = R \times A \times Cr$$

S = Mean rainwater supply in m<sup>3</sup>

R = Mean annual rainfall in mm/year

A = Surface area of catchment in m<sup>2</sup>

Cr = Run-off coefficient

The run-off coefficient accounts for losses due to splashing, evaporation, leakage and overflows and is normally taken to be 0.8 (80%).

The provision of the storage tank is the most costly element of a rainwater harvesting project, usually about 90% of the total cost. Storage can range from small containers made for other purposes, for example oil drums, food cans etc, up to large tanks of 150 cubic metres or more, at ground level, or sometimes beneath it. These larger tanks are made of concrete or ferrocement and are used as storage for schools, clinics or other institutions with large areas of roof.

### The Double Pit Latrine

---

A double pit latrine is a sanitation system specifically constructed to produce valuable fertilizer for gardens. It consists of two pits. As one is being used the other undergoes the process of composting.

#### **How the double pit latrine works**

The double pit latrine is designed so that human waste is transformed into fertilizer over a period of 12 months. In a normal latrine it would not be possible to achieve composting in only 12 months, but this can be done with the addition of soil, ash, and leaves to the pit. The volume of soil, ash, and leaves added to the pit should be equal to the volume of human waste, and should be distributed evenly throughout, that is to say, it should be added regularly. Fertilizer will not form if soil or ashes are added only occasionally. The transformation to fertilizer is also helped if the soil added is in itself fertile. Adding wet clay, for example, will not lead to a good fertilizer.

After each visit to the pit to defecate, a cup or tin of soil should be added. After urination it is not necessary to add anything, this may lead the pit to fill up rapidly and with too much soil. An additional advantage of using soil and especially ashes is the fact that they help to reduce odours. After 12 months of composting, the fertilizer can be removed from the pit and used in the garden. In order for this system to work, it is important that the pit that is being used is not filled completely within 12 months. The measures described here will fit for a household of six persons. The two pits that constitute the double pit latrine are shallow, each one being about 1.2 metres deep, with 1.5 being the maximum. It is recommended that the user mixes the contents of the pit from time to time so as to take advantage of all the available space and distribute the ingredients evenly. This helps the process of transforming the waste to fertilizer. When compared to a traditional sanitation system, the double pit latrine has several

#### **Advantages:**

- The excavation of the pit is relatively easy.
- There is a small quantity of material in each pit and it is quite porous, which permits more oxygen to enter and promotes the growth of beneficial microorganisms.
- The risks of contamination by ground water are reduced because the pit is relatively shallow.

Multiplication of harmful bacteria is also harnessed because of the composting process. It is important to avoid the simultaneous use of both pits. For the composting process to be

effective, it must be allowed to run for one year without new human waste being added. In order to reduce the likelihood of both pits being used simultaneously.

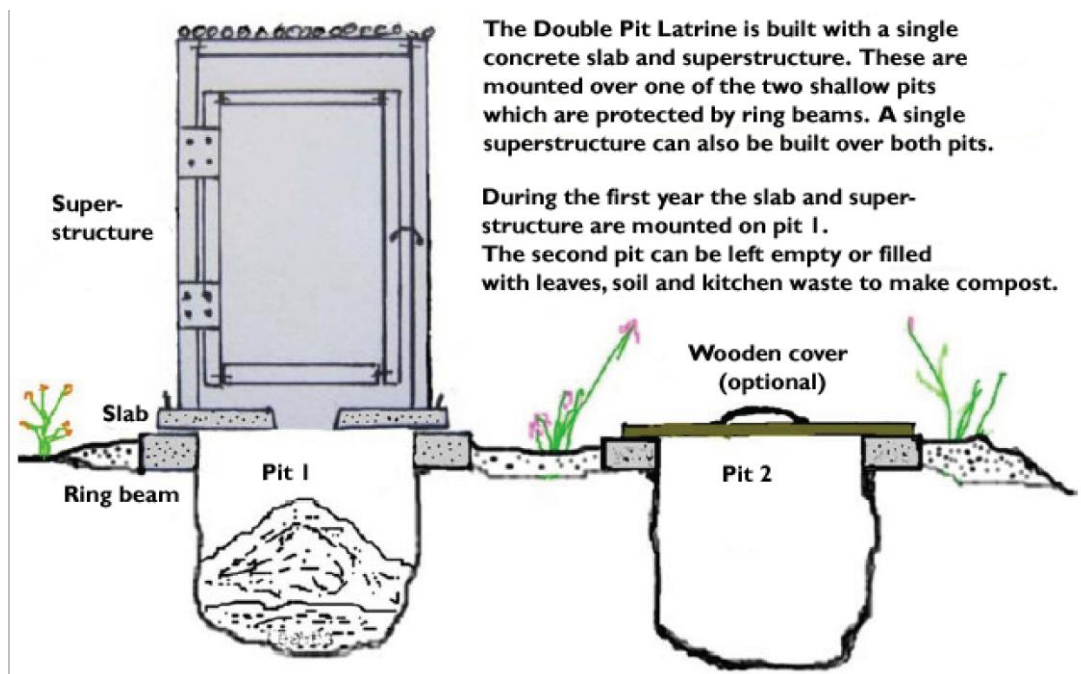

**Double Pit Latrine**  
**Fig. 18.3**

A foul water drainage system should

- (a) Convey the flow of foul water to a foul water outfall (a foul or combined sewer or a septic tank),
- (b) Minimize the risk of blockage or leakage,
- (c) Prevent foul air from the drainage system from entering the building under working conditions,
- (d) Be ventilated to prevent the build up of gases,
- (e) Be accessible for clearing blockages, and
- (f) Be adequately protected from accidental damage from sources such as traffic, ground settlement and tree roots.